

Title: ISO/IEC 10646 repertoire proposal post CDAM1.2

Source: Michel Suignard, Project editor

Status: Individual Contribution

Distribution: WG2

Reference: N5175

Executive Summary:

This document describes in detail most of the elements that could be included in a future amendment after ISO/IEC 10646 6th edition Amendment 1. These elements are also considered for a future version of the Unicode standard after version 15.0. While they don't constitute an exhaustive description of such a future amendment for ISO/10646 or a newer version of Unicode, they give some information about its repertoire content. As such they can be used to create a new modification to Program of Work to allow such a new amendment. The model follows the same template as N5175 which was describing the repertoire content for CDAM1.2 by describing affected blocks, code point extension and relevant documents.

Amendment 2 repertoire possible additions

The following represents all repertoire additions that could be part of the CDAM2 ballot document (first phase of the amendment process). All these additions had been discussed in the context of the Unicode Standard encoding process. Most of these have been approved for a future version of the Unicode standard (beyond Unicode 15.0 currently under beta review).

Some of these additions are modest extension of existing repertoires (such as Telugu, Kannada, Balinese, Latin, Arabic). Other such as the Myanmar extension adds a new block. There are also new proposed scripts:

- Toghri (historic script from the Albanian region of Elbasan)
- Garay (modern created script from Senegal used for Wolof and Mandinka language)
- Tulu-Tigalari (historic script from Karnataka and the northern districts of Kerala in India)
- Sunuwar (modern script used in Nepal and Sikkim, India by the Sunuwar community)
- Kirat Rai (used in Sikkim and West Bengal, India, for writing the Bantawa (Rai) language)

Finally, a large extension of symbols used for legacy computer and teletext, Smalltalk are also proposed. The following table includes all the proposed new ranges with pointers to the relevant documentations:

<i>Name</i>	<i>Ranges</i>	<i>Document(s)</i>
Telugu	0C5C	https://www.unicode.org/L2/L2022/22006-archaic-shrii.pdf
Kannada	0CDC	https://www.unicode.org/L2/L2022/22006-archaic-shrii.pdf
Balinese	1B4E-1B4F 1B7F	https://www.unicode.org/L2/L2022/22059-balinese-punct.pdf
Latin Extended-D	A7CB	https://www.unicode.org/L2/L2022/22045-capital-rams-horn.pdf
Toghri	105C0-105F3	https://www.unicode.org/wg2/docs/n5139r2-toghri.pdf
Garay	10D40-10D65 10D69-10D85 10D8E-10D8F	http://www.unicode.org/wg2/docs/n4709-garay-revision.pdf http://www.unicode.org/wg2/docs/n4875-17322-garay-progress.pdf https://www.unicode.org/L2/L2022/22048-garay-script.pdf
Arabic Extended-C	10EFC	https://www.unicode.org/L2/L2022/22047-combining-alef-overlay.pdf

<i>Name</i>	<i>Ranges</i>	<i>Document(s)</i>
Tulu-Tigalari	11380-11389 1138B-1138E 11390-113B5 113B7-113C0 113C2-113C5 113C7-113CA 113CC-113D1 113D4-113D5 113D7-113D8 113E1-113E2	http://www.unicode.org/L2/L2017/17378-tigalari.pdf https://www.unicode.org/L2/L2022/22031-tulu-tigalari-prop.pdf
Myanmar Extended-C	116D0-116E3	https://www.unicode.org/L2/L2022/22046-myanmar-numerals.pdf
Sunuwar	11BC0-11BE1 11BF0-11BF9	https://www.unicode.org/L2/L2021/21157r-sunuwar.pdf
Kirat Rai	16D40-16D79	https://www.unicode.org/L2/L2022/22043r-kirat-rai.pdf
Characters from legacy computers and teletext: Control Pictures: Symbols for Legacy Computing Supplement Supplemental Arrows-C Symbols for Legacy Computing	2427-2429 1CC00-1CCF9 1CD00-1CEAF 1F8B3-1F8BB 1FBCB-1FBEB	https://www.unicode.org/L2/L2021/21235r-terminals-supplement.pdf
Characters from Small-talk: Symbols for Legacy Computing Supplement Supplemental Arrows-C	1CEB0-1CEB3 1F8B2	https://www.unicode.org/L2/L2021/21234-terminals-smalltalk.pdf

The following pages show these new characters without the context of existing characters for blocks that already have encoded code points.

References

[N5175] CDAM1.2 repertoire status : <https://www.unicode.org/wg2/docs/n5175-cdam1.2-repertoire-update.pdf>

[N5181]: This document

	0C0	0C1	0C2	0C3	0C4	0C5	0C6	0C7
0								
1								
2								
3								
4								
5								
6								
7								
8								
9								
A								
B								
C						౩౦ 0C5C		
D								
E								
F								

UTC: 2022-01-25
contact: Srinidhi A
document: L2/22-006
font:
target: Unicode 16.0

Ligature

0C5C శ్రీ TELUGU ARCHAIC SHRII

- auspicious word shrii
- does not combine with other letters



	0C8	0C9	0CA	0CB	0CC	0CD	0CE	0CF
0								
1								
2								
3								
4								
5								
6								
7								
8								
9								
A								
B								
C						 0CDC		
D								
E								
F								

UTC: 2022-01-25
contact: Srinidhi A
document: L2/22-006
font:
target: Unicode 16.0

Ligature

0CDC ೀ KANNADA ARCHAIC SHRII

- auspicious word shrri
- does not combine with other letters

	1B0	1B1	1B2	1B3	1B4	1B5	1B6	1B7
0								
1								
2								
3								
4								
5								
6								
7								
8								
9								
A								
B								
C								
D								
E								
F								

UTC: 2022-01-25
contact: Rikza F. Sh
document: L2/22-059
font:
target: Unicode 16.0

Punctuation

may indicate emphasis or a finer division within text



1B4E \ BALINESE INVERTED CARIK SIKI

1B4F \| BALINESE INVERTED CARIK PAREREN





Punctuation

1B7F ^ BALINESE PANTI BAWAK

- may indicate a finer division within text

	240	241	242	243
0				
1				
2				
3				
4				
5				
6				
7			 2427	
8			 2428	
9			 2429	
A				
B				
C				
D				
E				
F				

Specific symbols for delete

- 2427  **SYMBOL FOR DELETE SQUARE CHECKER BOARD FORM**
- symbol for delete in the Apple II character set
 - fills the bounding box of 002B +
- 2428  **SYMBOL FOR DELETE RECTANGULAR CHECKER BOARD FORM**
- symbol for delete in the TRS-80 character set
 - fills the bounding box of 0048 **H**
- 2429  **SYMBOL FOR DELETE MEDIUM SHADE FORM**
- symbol for delete in the Amstrad CPC character set, which also encodes 2592  separately
 - fills the character cell
 - 2592  medium shade

UTC: 2022-01-25
 contact: Rebecca
 Bettencourt
 document: L2/21-
 235
 font: Kreative
 Square Unibook
 target: Unicode
 16.0

	A72	A73	A74	A75	A76	A77	A78	A79	A7A	A7B	A7C	A7D	A7E	A7F
0														
1														
2														
3														
4														
5														
6														
7														
8														
9														
A														
B														
C														
D														
E														
F														































































UTC: 2022-04-19
contact: Denis Moyogo
Jacquerey
document: L2/22-045
font:
target: Unicode 16.0

Additional letter for Eastern Dan (Africa)

A7CB Ƴ LATIN CAPITAL LETTER RAMS HORN

- lowercase is 0264 ƴ

→ 0194 Ƴ latin capital letter gamma

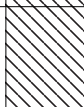
	105C	105D	105E	105F
0	 105C0	 105D0	 105E0	 105F0
1	 105C1	 105D1	 105E1	 105F1
2	 105C2	 105D2	 105E2	 105F2
3	 105C3	 105D3	 105E3	 105F3
4	 105C4	 105D4	 105E4	
5	 105C5	 105D5	 105E5	
6	 105C6	 105D6	 105E6	
7	 105C7	 105D7	 105E7	
8	 105C8	 105D8	 105E8	
9	 105C9	 105D9	 105E9	
A	 105CA	 105DA	 105EA	
B	 105CB	 105DB	 105EB	
C	 105CC	 105DC	 105EC	
D	 105CD	 105DD	 105ED	
E	 105CE	 105DE	 105EE	
F	 105CF	 105DF	 105EF	

UTC: 2022-04-19
 contact: Michael Everson
 document: L2/20-188r2 22-
 068
 font:
 target: Unicode 16.0

















































































Albanian letters

105C0	v	TODHRI LETTER A
105C1	ṿ	TODHRI LETTER AS
105C2	ṽ	TODHRI LETTER BA
105C3	ḷ	TODHRI LETTER MBA
105C4	Ḹ	TODHRI LETTER CA
105C5	q̣	TODHRI LETTER CHA
105C6	ʌ	TODHRI LETTER DA
105C7	xx	TODHRI LETTER NDA
105C8	ḽ	TODHRI LETTER DHA
105C9	i	TODHRI LETTER EI ≡ 105D2 i 0307 ı̇
105CA	ɹ	TODHRI LETTER E
105CB	Ḡ	TODHRI LETTER FA
105CC	h	TODHRI LETTER GA
105CD	ḥ	TODHRI LETTER NGA
105CE	ḡ	TODHRI LETTER GJA
105CF	Ḣ	TODHRI LETTER NGJA
105D0	€	TODHRI LETTER HA
105D1	ə	TODHRI LETTER HJA
105D2	i	TODHRI LETTER I
105D3	ɹ	TODHRI LETTER JA
105D4	c	TODHRI LETTER KA
105D5	q̣	TODHRI LETTER LA
105D6	Ḧ	TODHRI LETTER LLA
105D7	ç	TODHRI LETTER MA
105D8	v	TODHRI LETTER NA
105D9	ṿ	TODHRI LETTER NJAN
105DA	o	TODHRI LETTER O
105DB	ḽ	TODHRI LETTER PA
105DC	ɣ̣	TODHRI LETTER QA
105DD	ɣ̣	TODHRI LETTER RA
105DE	ʃ̣	TODHRI LETTER RRA
105DF	ẓ	TODHRI LETTER SA
105E0	ʃ̣	TODHRI LETTER SHA
105E1	ʃ̣	TODHRI LETTER SHTA • in origin a ligature of sha and ta
105E2	q̣	TODHRI LETTER TA
105E3	ɹ̣	TODHRI LETTER THA
105E4	ȯ	TODHRI LETTER U ≡ 105DA o 0307 ı̇
105E5	ℓ	TODHRI LETTER VA
105E6	ɹ̣	TODHRI LETTER XA
105E7	ẓ	TODHRI LETTER NXA
105E8	g̣	TODHRI LETTER XHA
105E9	g̣	TODHRI LETTER NXHA
105EA	ɣ̣	TODHRI LETTER Y
105EB	ḡ	TODHRI LETTER JY
105EC	ʃ̣	TODHRI LETTER ZA
105ED	ʃ̣	TODHRI LETTER ZHA

Greek letters

105EE	∇	TODHRI LETTER GH → 03B3 γ greek small letter gamma
105EF	5	TODHRI LETTER ST → 03DB Ϛ greek small letter stigma
105F0	8	TODHRI LETTER SK → 03BE ξ greek small letter ksi
105F1	X	TODHRI LETTER KH → 03C7 χ greek small letter chi
105F2	ϣ	TODHRI LETTER PS → 03C8 ψ greek small letter psi

105F3 ω TODHRI LETTER OO
 → 03C9 ω greek small letter omega

	10D4	10D5	10D6	10D7	10D8
0	 10D40	 10D50	 10D60	 10D70	 10D80
1	 10D41	 10D51	 10D61	 10D71	 10D81
2	 10D42	 10D52	 10D62	 10D72	 10D82
3	 10D43	 10D53	 10D63	 10D73	 10D83
4	 10D44	 10D54	 10D64	 10D74	 10D84
5	 10D45	 10D55	 10D65	 10D75	 10D85
6	 10D46	 10D56		 10D76	
7	 10D47	 10D57		 10D77	
8	 10D48	 10D58		 10D78	
9	 10D49	 10D59	 10D69	 10D79	
A	 10D4A	 10D5A	 10D6A	 10D7A	
B	 10D4B	 10D5B	 10D6B	 10D7B	
C	 10D4C	 10D5C	 10D6C	 10D7C	
D	 10D4D	 10D5D	 10D6D	 10D7D	
E	 10D4E	 10D5E	 10D6E	 10D7E	 10D8E
F	 10D4F	 10D5F	 10D6F	 10D7F	 10D8F

UTC: 2022-04-19
 contact: Andrii Rovenchak
 document: L2/22-048
 font:
 target: Unicode 16.0

Digits

10D40	○	GARAY DIGIT ZERO
10D41	∣	GARAY DIGIT ONE
10D42	∟	GARAY DIGIT TWO
10D43	∩	GARAY DIGIT THREE
10D44	∑	GARAY DIGIT FOUR
10D45	∩	GARAY DIGIT FIVE
10D46	∩	GARAY DIGIT SIX
10D47	∩	GARAY DIGIT SEVEN
10D48	∩	GARAY DIGIT EIGHT
10D49	∩	GARAY DIGIT NINE

Vowel signs

10D4A	/	GARAY VOWEL SIGN A
10D4B	\	GARAY VOWEL SIGN I
10D4C	,	GARAY VOWEL SIGN O
10D4D	∩	GARAY VOWEL SIGN EE
10D4E	_	GARAY VOWEL LENGTH MARK
10D4F	⋅	GARAY SUKUN

Capital consonant letters

10D50	∩	GARAY CAPITAL LETTER A
10D51	∩	GARAY CAPITAL LETTER CA
10D52	∩	GARAY CAPITAL LETTER MA
10D53	∩	GARAY CAPITAL LETTER KA
10D54	∩	GARAY CAPITAL LETTER BA
10D55	∩	GARAY CAPITAL LETTER JA
10D56	∩	GARAY CAPITAL LETTER SA
10D57	∩	GARAY CAPITAL LETTER WA
10D58	∩	GARAY CAPITAL LETTER LA
10D59	∩	GARAY CAPITAL LETTER GA
10D5A	∩	GARAY CAPITAL LETTER DA
10D5B	∩	GARAY CAPITAL LETTER XA
10D5C	∩	GARAY CAPITAL LETTER YA
10D5D	∩	GARAY CAPITAL LETTER TA
10D5E	∩	GARAY CAPITAL LETTER RA
10D5F	∩	GARAY CAPITAL LETTER NYA
10D60	∩	GARAY CAPITAL LETTER FA
10D61	∩	GARAY CAPITAL LETTER NA
10D62	∩	GARAY CAPITAL LETTER PA
10D63	∩	GARAY CAPITAL LETTER HA

Obsolete capital letter shapes

10D64	∩	GARAY CAPITAL LETTER OLD KA
10D65	∩	GARAY CAPITAL LETTER OLD NA

Garay diacritical marks

10D69	∩	GARAY VOWEL SIGN E
10D6A	∩	GARAY CONSONANT GEMINATION MARK
10D6B	∩	GARAY COMBINING DOT ABOVE
10D6C	∩	GARAY COMBINING DOUBLE DOT ABOVE
10D6D	∩	GARAY CONSONANT NASALIZATION MARK
10D6E	∩	GARAY HYPHEN
10D6F	∩	GARAY REDUPLICATION MARK

Small consonant letters

10D70	∩	GARAY SMALL LETTER A
10D71	∩	GARAY SMALL LETTER CA
10D72	∩	GARAY SMALL LETTER MA
10D73	∩	GARAY SMALL LETTER KA
10D74	∩	GARAY SMALL LETTER BA
10D75	∩	GARAY SMALL LETTER JA
10D76	∩	GARAY SMALL LETTER SA
10D77	∩	GARAY SMALL LETTER WA

10D78	∩	GARAY SMALL LETTER LA
10D79	∩	GARAY SMALL LETTER GA
10D7A	∩	GARAY SMALL LETTER DA
10D7B	∩	GARAY SMALL LETTER XA
10D7C	∩	GARAY SMALL LETTER YA
10D7D	∩	GARAY SMALL LETTER TA
10D7E	∩	GARAY SMALL LETTER RA
10D7F	∩	GARAY SMALL LETTER NYA
10D80	∩	GARAY SMALL LETTER FA
10D81	∩	GARAY SMALL LETTER NA
10D82	∩	GARAY SMALL LETTER PA
10D83	∩	GARAY SMALL LETTER HA

Obsolete small letter shapes

10D84	∩	GARAY SMALL LETTER OLD KA
10D85	∩	GARAY SMALL LETTER OLD NA

Mathematical notation

10D8E	∩	GARAY PLUS SIGN
10D8F	∩	GARAY MINUS SIGN

	10EC	10ED	10EE	10EF
0				
1				
2				
3				
4				
5				
6				
7				
8				
9				
A				
B				
C				 10EFC
D				
E				
F				

Quranic mark used in Libya

10EFC ☞ ARABIC COMBINING ALEF OVERLAY

- a vowel sign equivalent to 0670 اَ , only used to annotate lam
- 0670 اَ arabic letter superscript alef

UTC: 2022-04-19
contact: Lateef Sagar Shaikh
document: L2/22-047
font: target: Unicode 16.0

	1138	1139	113A	113B	113C	113D	113E	113F
0	ಅ 11380	ಋ 11390	ಢ 113A0	ಌ 113B0	಍ 113C0	ಏ 113D0		
1	ಉ 11381	ಊ 11391	ಋ 113A1	ಌ 113B1		಍ 113D1	ಏ 113E1	
2	ಉ 11382	ಊ 11392	ಋ 113A2	ಌ 113B2	಍ 113C2		ಏ 113E2	
3	ಉ 11383	ಊ 11393	ಋ 113A3	ಌ 113B3				
4	ಉ 11384	ಊ 11394	ಋ 113A4	ಌ 113B4		಍ 113D4		
5	ಉ 11385	ಊ 11395	ಋ 113A5	ಌ 113B5	಍ 113C5	ಏ 113D5		
6	ಉ 11386	ಊ 11396	ಋ 113A6					
7	ಉ 11387	ಊ 11397	ಋ 113A7	ಌ 113B7	಍ 113C7	ಏ 113D7		
8	ಉ 11388	ಊ 11398	ಋ 113A8	ಌ 113B8	಍ 113C8	ಏ 113D8		
9	ಉ 11389	ಊ 11399	ಋ 113A9	ಌ 113B9	಍ 113C9			
A		ಉ 1139A	ಊ 113AA	ಋ 113BA	ಌ 113CA			
B	ಉ 1138B	ಊ 1139B	ಋ 113AB	ಌ 113BB				
C		ಉ 1139C	ಊ 113AC	ಋ 113BC	ಌ 113CC			
D		ಉ 1139D	ಊ 113AD	ಋ 113BD	ಌ 113CD			
E	ಉ 1138E	ಊ 1139E	ಋ 113AE	ಌ 113BE	಍ 113CE			
F		ಉ 1139F	ಊ 113AF	ಋ 113BF	ಌ 113CF			

UTC: 2022-01-25
 contact: Vinodh Rajan
 document: L2/22-031
 font:
 target: Unicode 16.0

Independent vowels

11380	᱁	TULU-TIGALARI LETTER A
11381	᱂	TULU-TIGALARI LETTER AA
11382	᱃	TULU-TIGALARI LETTER I
11383	᱄	TULU-TIGALARI LETTER II ≡ 11382 ᱃ 113C9 ᱅
11384	᱅	TULU-TIGALARI LETTER U
11385	᱆	TULU-TIGALARI LETTER UU ≡ 11384 ᱅ 113BB ᱇
11386	᱇	TULU-TIGALARI LETTER VOCALIC R
11387	᱈	TULU-TIGALARI LETTER VOCALIC RR
11388	᱉	TULU-TIGALARI LETTER VOCALIC L
11389	᱊	TULU-TIGALARI LETTER VOCALIC LL
1138A	᱋	<reserved>
1138B	᱌	TULU-TIGALARI LETTER EE
1138C	ᱍ	<reserved>
1138D	ᱎ	<reserved>
1138E	ᱏ	TULU-TIGALARI LETTER AI ≡ 1138B ᱌ 113C2 ᱑
1138F	᱐	<reserved>
11390	᱑	TULU-TIGALARI LETTER OO
11391	᱒	TULU-TIGALARI LETTER AU ≡ 11390 ᱑ 113C9 ᱅

Consonants

11392	᱓	TULU-TIGALARI LETTER KA
11393	᱔	TULU-TIGALARI LETTER KHA
11394	᱕	TULU-TIGALARI LETTER GA
11395	᱖	TULU-TIGALARI LETTER GHA
11396	᱗	TULU-TIGALARI LETTER NGA
11397	᱘	TULU-TIGALARI LETTER CA
11398	᱙	TULU-TIGALARI LETTER CHA
11399	ᱚ	TULU-TIGALARI LETTER JA
1139A	ᱛ	TULU-TIGALARI LETTER JHA
1139B	ᱜ	TULU-TIGALARI LETTER NYA
1139C	ᱝ	TULU-TIGALARI LETTER TTA
1139D	ᱞ	TULU-TIGALARI LETTER TTHA
1139E	ᱟ	TULU-TIGALARI LETTER DDA
1139F	ᱠ	TULU-TIGALARI LETTER DDHA
113A0	ᱡ	TULU-TIGALARI LETTER NNA
113A1	ᱢ	TULU-TIGALARI LETTER TA
113A2	ᱣ	TULU-TIGALARI LETTER THA
113A3	ᱤ	TULU-TIGALARI LETTER DA
113A4	ᱥ	TULU-TIGALARI LETTER DHA
113A5	ᱦ	TULU-TIGALARI LETTER NA
113A6	ᱧ	TULU-TIGALARI LETTER PA
113A7	ᱨ	TULU-TIGALARI LETTER PHA
113A8	ᱩ	TULU-TIGALARI LETTER BA
113A9	ᱪ	TULU-TIGALARI LETTER BHA
113AA	ᱫ	TULU-TIGALARI LETTER MA
113AB	ᱬ	TULU-TIGALARI LETTER YA
113AC	ᱭ	TULU-TIGALARI LETTER RA
113AD	ᱮ	TULU-TIGALARI LETTER LA
113AE	ᱯ	TULU-TIGALARI LETTER VA
113AF	ᱰ	TULU-TIGALARI LETTER SHA
113B0	ᱱ	TULU-TIGALARI LETTER SSA
113B1	ᱲ	TULU-TIGALARI LETTER SA
113B2	ᱳ	TULU-TIGALARI LETTER HA
113B3	ᱴ	TULU-TIGALARI LETTER LLA
113B4	ᱵ	TULU-TIGALARI LETTER RRA
113B5	ᱶ	TULU-TIGALARI LETTER LLLA

Sign

113B7 ᱷ TULU-TIGALARI SIGN AVAGRAHA

Dependent vowel signs

113B8	ᱸ	TULU-TIGALARI VOWEL SIGN AA
113B9	ᱹ	TULU-TIGALARI VOWEL SIGN I
113BA	ᱺ	TULU-TIGALARI VOWEL SIGN II
113BB	ᱻ	TULU-TIGALARI VOWEL SIGN U
113BC	ᱼ	TULU-TIGALARI VOWEL SIGN UU
113BD	ᱽ	TULU-TIGALARI VOWEL SIGN VOCALIC R
113BE	᱾	TULU-TIGALARI VOWEL SIGN VOCALIC RR
113BF	᱿	TULU-TIGALARI VOWEL SIGN VOCALIC L
113C0	᱀	TULU-TIGALARI VOWEL SIGN VOCALIC LL
113C1	᱁	<reserved>
113C2	᱂	TULU-TIGALARI VOWEL SIGN EE
113C3	᱃	<reserved>
113C4	᱄	<reserved>
113C5	᱅	TULU-TIGALARI VOWEL SIGN AI ≡ 113C2 ᱂ 113C2 ᱑
113C6	᱆	<reserved>
113C7	᱇	TULU-TIGALARI VOWEL SIGN OO ≡ 113C2 ᱑ 113B8 ᱸ
113C8	᱈	TULU-TIGALARI VOWEL SIGN AU ≡ 113C2 ᱑ 113C9 ᱅

Various signs

113C9	᱉	TULU-TIGALARI AU LENGTH MARK
113CA	᱊	TULU-TIGALARI SIGN CANDRA ANUNASIKA
113CB	᱋	<reserved>
113CC	᱌	TULU-TIGALARI SIGN ANUSVARA
113CD	ᱍ	TULU-TIGALARI SIGN VISARGA
113CE	ᱎ	TULU-TIGALARI SIGN VIRAMA
113CF	ᱏ	TULU-TIGALARI SIGN LOOPED VIRAMA
113D0	᱐	TULU-TIGALARI CONJOINER • creates conjuncts
113D1	᱑	TULU-TIGALARI REPHA

Punctuation

113D4	᱒	TULU-TIGALARI DANDA
113D5	᱓	TULU-TIGALARI DOUBLE DANDA
113D6	᱔	<reserved>
113D7	᱕	TULU-TIGALARI SIGN OM PUSHPIKA
113D8	᱖	TULU-TIGALARI SIGN SHRII PUSHPIKA

Vedic tones

113E1	᱗	TULU-TIGALARI VEDIC TONE SVARITA
113E2	᱘	TULU-TIGALARI VEDIC TONE ANUDATTA

	116D	116E	116F
0	0 116D0	၄ 116E0	
1	၇ 116D1	၁ 116E1	
2	၂ 116D2	၈ 116E2	
3	၃ 116D3	၉ 116E3	
4	၄ 116D4		
5	၅ 116D5		
6	၆ 116D6		
7	၇ 116D7		
8	၈ 116D8		
9	၉ 116D9		
A	၀ 116DA		
B	၁ 116DB		
C	၂ 116DC		
D	၃ 116DD		
E	၄ 116DE		
F	၅ 116DF		

Pa'o digits

- 116D0 ၀ MYANMAR PAO DIGIT ZERO
- 116D1 ၇ MYANMAR PAO DIGIT ONE
- 116D2 ၂ MYANMAR PAO DIGIT TWO
- 116D3 ၃ MYANMAR PAO DIGIT THREE
- 116D4 ၄ MYANMAR PAO DIGIT FOUR
- 116D5 ၅ MYANMAR PAO DIGIT FIVE
- 116D6 ၆ MYANMAR PAO DIGIT SIX
- 116D7 ၇ MYANMAR PAO DIGIT SEVEN
- 116D8 ၈ MYANMAR PAO DIGIT EIGHT
- 116D9 ၉ MYANMAR PAO DIGIT NINE

Eastern Pwo Karen digits

- 116DA ၀ MYANMAR EASTERN PWO KAREN DIGIT ZERO
- 116DB ၁ MYANMAR EASTERN PWO KAREN DIGIT ONE
- 116DC ၂ MYANMAR EASTERN PWO KAREN DIGIT TWO
- 116DD ၃ MYANMAR EASTERN PWO KAREN DIGIT THREE
- 116DE ၄ MYANMAR EASTERN PWO KAREN DIGIT FOUR
- 116DF ၅ MYANMAR EASTERN PWO KAREN DIGIT FIVE
- 116E0 ၆ MYANMAR EASTERN PWO KAREN DIGIT SIX
- 116E1 ၇ MYANMAR EASTERN PWO KAREN DIGIT SEVEN
- 116E2 ၈ MYANMAR EASTERN PWO KAREN DIGIT EIGHT
- 116E3 ၉ MYANMAR EASTERN PWO KAREN DIGIT NINE

UTC: 2022-01-25
 contact: Ben Mitchell
 document: L2/22-046
 font: target: Unicode 16.0

	11BC	11BD	11BE	11BF
0	𑄀 11BC0	𑄁 11BD0	𑄂 11BE0	𑄃 11BF0
1	𑄄 11BC1	𑄅 11BD1	𑄆 11BE1	𑄇 11BF1
2	𑄈 11BC2	𑄉 11BD2		𑄊 11BF2
3	𑄋 11BC3	𑄌 11BD3		𑄍 11BF3
4	𑄎 11BC4	𑄏 11BD4		𑄐 11BF4
5	𑄑 11BC5	𑄒 11BD5		𑄓 11BF5
6	𑄔 11BC6	𑄕 11BD6		𑄖 11BF6
7	𑄗 11BC7	𑄘 11BD7		𑄙 11BF7
8	𑄚 11BC8	𑄛 11BD8		𑄜 11BF8
9	𑄝 11BC9	𑄞 11BD9		𑄟 11BF9
A	𑄠 11BCA	𑄡 11BDA		
B	𑄢 11BCB	𑄣 11BDB		
C	𑄤 11BCC	𑄥 11BDC		
D	𑄧 11BCD	𑄨 11BDD		
E	𑄩 11BCE	𑄪 11BDE		
F	𑄫 11BCF	𑄬 11BDF		

The script is known indigenously as 'Koinch brese'

Letters

11BC0	𑄀	SUNUWAR LETTER DEVI
11BC1	𑄁	SUNUWAR LETTER TASLA
11BC2	𑄂	SUNUWAR LETTER EKO
11BC3	𑄃	SUNUWAR LETTER IMAR
11BC4	𑄄	SUNUWAR LETTER REU
11BC5	𑄅	SUNUWAR LETTER UTTHI
11BC6	𑄆	SUNUWAR LETTER KIK
11BC7	𑄇	SUNUWAR LETTER MA
11BC8	𑄈	SUNUWAR LETTER APPHO
11BC9	𑄉	SUNUWAR LETTER PIP
11BCA	𑄊	SUNUWAR LETTER GIL
11BCB	𑄋	SUNUWAR LETTER HAMSO
11BCC	𑄌	SUNUWAR LETTER CARMi
11BCD	𑄍	SUNUWAR LETTER NAH
11BCE	𑄎	SUNUWAR LETTER BUR
11BCF	𑄏	SUNUWAR LETTER JYAH
11BD0	𑄐	SUNUWAR LETTER LOACHA
11BD1	𑄑	SUNUWAR LETTER OTTHI
11BD2	𑄒	SUNUWAR LETTER SHYELE
11BD3	𑄓	SUNUWAR LETTER VARCA
11BD4	𑄔	SUNUWAR LETTER YAT
11BD5	𑄕	SUNUWAR LETTER AVA
11BD6	𑄖	SUNUWAR LETTER AAL
11BD7	𑄗	SUNUWAR LETTER DONGA
11BD8	𑄘	SUNUWAR LETTER THARI
11BD9	𑄙	SUNUWAR LETTER PHAR
11BDA	𑄚	SUNUWAR LETTER NGAR
11BDB	𑄛	SUNUWAR LETTER KHA
11BDC	𑄜	SUNUWAR LETTER SHYER
11BDD	𑄝	SUNUWAR LETTER CHELAP
11BDE	𑄞	SUNUWAR LETTER TENTU
11BDF	𑄟	SUNUWAR LETTER THELE
11BE0	𑄠	SUNUWAR LETTER KLOKO

Auspicious sign

11BE1 𑄡 SUNUWAR SIGN PVO

Digits

11BF0	𑄃	SUNUWAR DIGIT ZERO
11BF1	𑄇	SUNUWAR DIGIT ONE
11BF2	𑄊	SUNUWAR DIGIT TWO
11BF3	𑄍	SUNUWAR DIGIT THREE
11BF4	𑄐	SUNUWAR DIGIT FOUR
11BF5	𑄓	SUNUWAR DIGIT FIVE
11BF6	𑄖	SUNUWAR DIGIT SIX
11BF7	𑄙	SUNUWAR DIGIT SEVEN
11BF8	𑄜	SUNUWAR DIGIT EIGHT
11BF9	𑄟	SUNUWAR DIGIT NINE

	16D4	16D5	16D6	16D7
0	◦ 16D40	उ 16D50	र 16D60	0 16D70
1	◌ 16D41	क 16D51	ल 16D61	३ 16D71
2	◌ 16D42	ग 16D52	ख 16D62	४ 16D72
3	अ 16D43	घ 16D53	। 16D63	५ 16D73
4	क 16D44	ङ 16D54	॥ 16D64	६ 16D74
5	ख 16D45	च 16D55	र 16D65	७ 16D75
6	ग 16D46	छ 16D56	र 16D66	८ 16D76
7	घ 16D47	प 16D57	र 16D67	९ 16D77
8	ङ 16D48	फ 16D58	र 16D68	१० 16D78
9	च 16D49	ठ 16D59	र 16D69	११ 16D79
A	ॐ 16D4A	ॐ 16D5A	ॐ 16D6A	
B	ॐ 16D4B	ॐ 16D5B	- 16D6B	
C	ॐ 16D4C	ॐ 16D5C	^ 16D6C	
D	ॐ 16D4D	ॐ 16D5D	◦ 16D6D	
E	ॐ 16D4E	ॐ 16D5E	/ 16D6E	
F	ॐ 16D4F	ॐ 16D5F	// 16D6F	

UTC: 2022-04-19
 contact: Lorna Evans
 document: L2/22-043R
 font:
 target: Unicode 16.0

Various signs

- 16D40 ◌ KIRAT RAI SIGN ANUSVARA
 → 02DA ◌ ring above
- 16D41 ◌ KIRAT RAI SIGN TONPI
- 16D42 ◌ KIRAT RAI SIGN VISARGA
 → A789: modifier letter colon

Letters

- 16D43 ೀ KIRAT RAI LETTER A
 • also used as a vowel carrier
- 16D44 ು KIRAT RAI LETTER KA
- 16D45 ೂ KIRAT RAI LETTER KHA
- 16D46 ೃ KIRAT RAI LETTER GA
- 16D47 ೄ KIRAT RAI LETTER GHA
- 16D48 ೅ KIRAT RAI LETTER NGA
- 16D49 ೆ KIRAT RAI LETTER CA
- 16D4A ೇ KIRAT RAI LETTER CHA
- 16D4B ೈ KIRAT RAI LETTER JA
- 16D4C ೉ KIRAT RAI LETTER JHA
- 16D4D ೊ KIRAT RAI LETTER NYA
- 16D4E ೋ KIRAT RAI LETTER TTA
- 16D4F ೌ KIRAT RAI LETTER TTHA
- 16D50 ್ KIRAT RAI LETTER DDA
- 16D51 ೎ KIRAT RAI LETTER DDHA
- 16D52 ೏ KIRAT RAI LETTER TA
- 16D53 ೐ KIRAT RAI LETTER THA
- 16D54 ೑ KIRAT RAI LETTER DA
- 16D55 ೒ KIRAT RAI LETTER DHA
- 16D56 ೓ KIRAT RAI LETTER NA
- 16D57 ೔ KIRAT RAI LETTER PA
- 16D58 ೕ KIRAT RAI LETTER PHA
- 16D59 ೖ KIRAT RAI LETTER BA
- 16D5A ೗ KIRAT RAI LETTER BHA
- 16D5B ೘ KIRAT RAI LETTER MA
- 16D5C ೙ KIRAT RAI LETTER YA
- 16D5D ೚ KIRAT RAI LETTER RA
- 16D5E ೛ KIRAT RAI LETTER LA
- 16D5F ೜ KIRAT RAI LETTER VA
- 16D60 ೝ KIRAT RAI LETTER SA
- 16D61 ೞ KIRAT RAI LETTER SHA
- 16D62 ೟ KIRAT RAI LETTER HA

Vowel signs

- 16D63 | KIRAT RAI VOWEL SIGN AA
 → 007C | vertical line
 → 0964 | devanagari danda
- 16D64 \ KIRAT RAI VOWEL SIGN I
- 16D65 Ū KIRAT RAI VOWEL SIGN U
- 16D66 ū KIRAT RAI VOWEL SIGN UE
- 16D67 e KIRAT RAI VOWEL SIGN E
- 16D68 ee KIRAT RAI VOWEL SIGN AI
 ≡ 16D67 e 16D67 e
- 16D69 Ie KIRAT RAI VOWEL SIGN O
 ≡ 16D63 | 16D67 e
- 16D6A Iee IRAT RAI VOWEL SIGN AU
 ≡ 16D69 Ie 16D67 e

Various signs

- 16D6B _ KIRAT RAI SIGN VIRAMA
 → 02CD _ modifier letter low macron
- 16D6C ^ KIRAT RAI SIGN SAAT
 → 02F0 ^ modifier letter low up arrowhead

- 16D6D ◌ KIRAT RAI SIGN YUPI
 • intended for Kirat Rai-specific abbreviations
 → 02F3 ◌ modifier letter low ring
 → 0970 ◌ devanagari abbreviation sign

Punctuation































































































































































































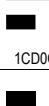
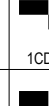
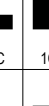
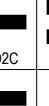

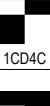
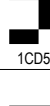
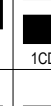
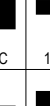
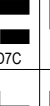
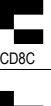
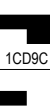
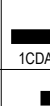
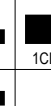

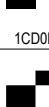
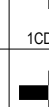
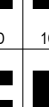
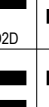
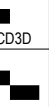
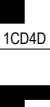

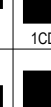
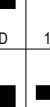
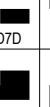

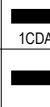
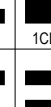



















- 16D6E / KIRAT RAI DANDA
 = danda
 → 0964 | devanagari danda
- 16D6F // KIRAT RAI DOUBLE DANDA
 = double danda
 → 0965 || devanagari double danda

Digits

- 16D70 0 KIRAT RAI DIGIT ZERO
- 16D71 ॑ KIRAT RAI DIGIT ONE
- 16D72 ॒ KIRAT RAI DIGIT TWO
- 16D73 ॒ KIRAT RAI DIGIT THREE
- 16D74 ॒ KIRAT RAI DIGIT FOUR
- 16D75 ॒ KIRAT RAI DIGIT FIVE
- 16D76 ॒ KIRAT RAI DIGIT SIX
- 16D77 ॒ KIRAT RAI DIGIT SEVEN
- 16D78 ॒ KIRAT RAI DIGIT EIGHT
- 16D79 ॒ KIRAT RAI DIGIT NINE

	1CC0	1CC1	1CC2	1CC3	1CC4	1CC5	1CC6	1CC7	1CC8	1CC9	1CCA	1CCB	1CCC	1CCD	1CCE
0	1CC00	1CC10	1CC20	1CC30	1CC40	1CC50	1CC60	1CC70	1CC80	1CC90	1CCA0	1CCB0	1CCC0	1CCD0	1CCE0
1	1CC01	1CC11	1CC21	1CC31	1CC41	1CC51	1CC61	1CC71	1CC81	1CC91	1CCA1	1CCB1	1CCC1	1CCD1	1CCE1
2	1CC02	1CC12	1CC22	1CC32	1CC42	1CC52	1CC62	1CC72	1CC82	1CC92	1CCA2	1CCB2	1CCC2	1CCD2	1CCE2
3	1CC03	1CC13	1CC23	1CC33	1CC43	1CC53	1CC63	1CC73	1CC83	1CC93	1CCA3	1CCB3	1CCC3	1CCD3	1CCE3
4	1CC04	1CC14	1CC24	1CC34	1CC44	1CC54	1CC64	1CC74	1CC84	1CC94	1CCA4	1CCB4	1CCC4	1CCD4	1CCE4
5	1CC05	1CC15	1CC25	1CC35	1CC45	1CC55	1CC65	1CC75	1CC85	1CC95	1CCA5	1CCB5	1CCC5	1CCD5	1CCE5
6	1CC06	1CC16	1CC26	1CC36	1CC46	1CC56	1CC66	1CC76	1CC86	1CC96	1CCA6	1CCB6	1CCC6	1CCD6	1CCE6
7	1CC07	1CC17	1CC27	1CC37	1CC47	1CC57	1CC67	1CC77	1CC87	1CC97	1CCA7	1CCB7	1CCC7	1CCD7	1CCE7
8	1CC08	1CC18	1CC28	1CC38	1CC48	1CC58	1CC68	1CC78	1CC88	1CC98	1CCA8	1CCB8	1CCC8	1CCD8	1CCE8
9	1CC09	1CC19	1CC29	1CC39	1CC49	1CC59	1CC69	1CC79	1CC89	1CC99	1CCA9	1CCB9	1CCC9	1CCD9	1CCE9
A	1CC0A	1CC1A	1CC2A	1CC3A	1CC4A	1CC5A	1CC6A	1CC7A	1CC8A	1CC9A	1CCA A	1CCBA	1CCC A	1CCDA	1CCE A
B	1CC0B	1CC1B	1CC2B	1CC3B	1CC4B	1CC5B	1CC6B	1CC7B	1CC8B	1CC9B	1CCA B	1CCBB	1CCCB	1CCDB	1CCE B
C	1CC0C	1CC1C	1CC2C	1CC3C	1CC4C	1CC5C	1CC6C	1CC7C	1CC8C	1CC9C	1CCA C	1CCBC	1CCC C	1CCDC	1CCE C
D	1CC0D	1CC1D	1CC2D	1CC3D	1CC4D	1CC5D	1CC6D	1CC7D	1CC8D	1CC9D	1CCA D	1CCBD	1CCCD	1CCDD	1CCE D
E	1CC0E	1CC1E	1CC2E	1CC3E	1CC4E	1CC5E	1CC6E	1CC7E	1CC8E	1CC9E	1CCA E	1CCBE	1CCCE	1CCDE	1CCE E
F	1CC0F	1CC1F	1CC2F	1CC3F	1CC4F	1CC5F	1CC6F	1CC7F	1CC8F	1CC9F	1CCA F	1CCBF	1CCCF	1CCDF	1CCE F





1CCF 1CD0 1CD1 1CD2 1CD3 1CD4 1CD5 1CD6 1CD7 1CD8 1CD9 1CDA 1CDB 1CDC 1CDD

0	 1CCF0	 1CD00	 1CD10	 1CD20	 1CD30	 1CD40	 1CD50	 1CD60	 1CD70	 1CD80	 1CD90	 1CDA0	 1CDB0	 1CDC0	 1CDD0
1	 1CCF1	 1CD01	 1CD11	 1CD21	 1CD31	 1CD41	 1CD51	 1CD61	 1CD71	 1CD81	 1CD91	 1CDA1	 1CDB1	 1CDC1	 1CDD1
2	 1CCF2	 1CD02	 1CD12	 1CD22	 1CD32	 1CD42	 1CD52	 1CD62	 1CD72	 1CD82	 1CD92	 1CDA2	 1CDB2	 1CDC2	 1CDD2
3	 1CCF3	 1CD03	 1CD13	 1CD23	 1CD33	 1CD43	 1CD53	 1CD63	 1CD73	 1CD83	 1CD93	 1CDA3	 1CDB3	 1CDC3	 1CDD3
4	 1CCF4	 1CD04	 1CD14	 1CD24	 1CD34	 1CD44	 1CD54	 1CD64	 1CD74	 1CD84	 1CD94	 1CDA4	 1CDB4	 1CDC4	 1CDD4
5	 1CCF5	 1CD05	 1CD15	 1CD25	 1CD35	 1CD45	 1CD55	 1CD65	 1CD75	 1CD85	 1CD95	 1CDA5	 1CDB5	 1CDC5	 1CDD5
6	 1CCF6	 1CD06	 1CD16	 1CD26	 1CD36	 1CD46	 1CD56	 1CD66	 1CD76	 1CD86	 1CD96	 1CDA6	 1CDB6	 1CDC6	 1CDD6
7	 1CCF7	 1CD07	 1CD17	 1CD27	 1CD37	 1CD47	 1CD57	 1CD67	 1CD77	 1CD87	 1CD97	 1CDA7	 1CDB7	 1CDC7	 1CDD7
8	 1CCF8	 1CD08	 1CD18	 1CD28	 1CD38	 1CD48	 1CD58	 1CD68	 1CD78	 1CD88	 1CD98	 1CDA8	 1CDB8	 1CDC8	 1CDD8
9	 1CCF9	 1CD09	 1CD19	 1CD29	 1CD39	 1CD49	 1CD59	 1CD69	 1CD79	 1CD89	 1CD99	 1CDA9	 1CDB9	 1CDC9	 1CDD9
A		 1CD0A	 1CD1A	 1CD2A	 1CD3A	 1CD4A	 1CD5A	 1CD6A	 1CD7A	 1CD8A	 1CD9A	 1CDA A	 1CDB A	 1CDC A	 1CDD A
B		 1CD0B	 1CD1B	 1CD2B	 1CD3B	 1CD4B	 1CD5B	 1CD6B	 1CD7B	 1CD8B	 1CD9B	 1CDA B	 1CDB B	 1CDC B	 1CDD B
C		 1CD0C	 1CD1C	 1CD2C	 1CD3C	 1CD4C	 1CD5C	 1CD6C	 1CD7C	 1CD8C	 1CD9C	 1CDA C	 1CDB C	 1CDC C	 1CDD C
D		 1CD0D	 1CD1D	 1CD2D	 1CD3D	 1CD4D	 1CD5D	 1CD6D	 1CD7D	 1CD8D	 1CD9D	 1CDA D	 1CDB D	 1CDC D	 1CDD D
E		 1CD0E	 1CD1E	 1CD2E	 1CD3E	 1CD4E	 1CD5E	 1CD6E	 1CD7E	 1CD8E	 1CD9E	 1CDA E	 1CDB E	 1CDC E	 1CDD E
F		 1CD0F	 1CD1F	 1CD2F	 1CD3F	 1CD4F	 1CD5F	 1CD6F	 1CD7F	 1CD8F	 1CD9F	 1CDA F	 1CDB F	 1CDC F	 1CDD F

	1CDE	1CDF	1CE0	1CE1	1CE2	1CE3	1CE4	1CE5	1CE6	1CE7	1CE8	1CE9	1CEA	1CEB
0	1CDE0	1CDF0	1CE00	1CE10	1CE20	1CE30	1CE40	1CE50	1CE60	1CE70	1CE80	1CE90	1CEA0	1CEB0
1	1CDE1	1CDF1	1CE01	1CE11	1CE21	1CE31	1CE41	1CE51	1CE61	1CE71	1CE81	1CE91	1CEA1	1CEB1
2	1CDE2	1CDF2	1CE02	1CE12	1CE22	1CE32	1CE42	1CE52	1CE62	1CE72	1CE82	1CE92	1CEA2	1CEB2
3	1CDE3	1CDF3	1CE03	1CE13	1CE23	1CE33	1CE43	1CE53	1CE63	1CE73	1CE83	1CE93	1CEA3	1CEB3
4	1CDE4	1CDF4	1CE04	1CE14	1CE24	1CE34	1CE44	1CE54	1CE64	1CE74	1CE84	1CE94	1CEA4	
5	1CDE5	1CDF5	1CE05	1CE15	1CE25	1CE35	1CE45	1CE55	1CE65	1CE75	1CE85	1CE95	1CEA5	
6	1CDE6	1CDF6	1CE06	1CE16	1CE26	1CE36	1CE46	1CE56	1CE66	1CE76	1CE86	1CE96	1CEA6	
7	1CDE7	1CDF7	1CE07	1CE17	1CE27	1CE37	1CE47	1CE57	1CE67	1CE77	1CE87	1CE97	1CEA7	
8	1CDE8	1CDF8	1CE08	1CE18	1CE28	1CE38	1CE48	1CE58	1CE68	1CE78	1CE88	1CE98	1CEA8	
9	1CDE9	1CDF9	1CE09	1CE19	1CE29	1CE39	1CE49	1CE59	1CE69	1CE79	1CE89	1CE99	1CEA9	
A	1CDEA	1CDFA	1CE0A	1CE1A	1CE2A	1CE3A	1CE4A	1CE5A	1CE6A	1CE7A	1CE8A	1CE9A	1CEAA	
B	1CDEB	1CDFB	1CE0B	1CE1B	1CE2B	1CE3B	1CE4B	1CE5B	1CE6B	1CE7B	1CE8B	1CE9B	1CEAB	
C	1CDEC	1CDFC	1CE0C	1CE1C	1CE2C	1CE3C	1CE4C	1CE5C	1CE6C	1CE7C	1CE8C	1CE9C	1CEAC	
D	1CDED	1CDFD	1CE0D	1CE1D	1CE2D	1CE3D	1CE4D	1CE5D	1CE6D	1CE7D	1CE8D	1CE9D	1CEAD	
E	1CDEE	1CDFE	1CE0E	1CE1E	1CE2E	1CE3E	1CE4E	1CE5E	1CE6E	1CE7E	1CE8E	1CE9E	1CEAE	
F	1CDEF	1CDFF	1CE0F	1CE1F	1CE2F	1CE3F	1CE4F	1CE5F	1CE6F	1CE7F	1CE8F	1CE9F	1CEAF	

UTC: 2022-01-25
 contact: Rebecca Bettencourt
 document: L2/21-234 L2/21-
 235
 font: Kreative Square
 Unibook
 target: Unicode 15.0

Game sprites



















- 1CC00  UP-POINTING GO-KART
 1CC01  RIGHT-POINTING GO-KART
 1CC02  LEFT-POINTING STICK FIGURE
 → 1FBC5  stick figure
 1CC03  RIGHT-POINTING STICK FIGURE
 1CC04  DOWN-POINTING STICK FIGURE

Ruler segments







- 1CC05  LOWER HORIZONTAL RULER SEGMENT
 1CC06  RIGHT VERTICAL RULER SEGMENT
 1CC07  LOWER RIGHT RULER SEGMENT

Schematic symbols

Designed to be used with light box drawing characters.













- 1CC08  ANTENNA
 1CC09  HORIZONTAL RESISTOR SEGMENT
 1CC0A  VERTICAL RESISTOR SEGMENT
 1CC0B  LEFT THIRD INDUCTOR
 1CC0C  MIDDLE THIRD INDUCTOR
 1CC0D  RIGHT THIRD INDUCTOR
 1CC0E  LEFT-POINTING DIODE
 1CC0F  RIGHT-POINTING DIODE
 1CC10  NPN TRANSISTOR
 1CC11  PNP TRANSISTOR
 1CC12  RECEPTACLE
 1CC13  HORIZONTAL CAPACITOR
 1CC14  VERTICAL CAPACITOR
 1CC15  LOGIC GATE OR
 1CC16  LOGIC GATE AND
 1CC17  LOGIC GATE INVERTED INPUTS
 1CC18  LOGIC GATE INVERTED OUTPUT
 1CC19  LOGIC GATE BUFFER
 1CC1A  LOGIC GATE BUFFER WITH INVERTED INPUT



















Box drawing characters

- 1CC1B  BOX DRAWINGS LIGHT HORIZONTAL AND UPPER RIGHT
 1CC1C  BOX DRAWINGS LIGHT HORIZONTAL AND LOWER RIGHT
 1CC1D  BOX DRAWINGS LIGHT TOP AND UPPER LEFT
 1CC1E  BOX DRAWINGS LIGHT BOTTOM AND LOWER LEFT
 1CC1F  BOX DRAWINGS DOUBLE DIAGONAL UPPER RIGHT TO LOWER LEFT
 1CC20  BOX DRAWINGS DOUBLE DIAGONAL UPPER LEFT TO LOWER RIGHT

















Separated mosaic terminal graphic characters

The term "quadrant" refers to block mosaics divided into four parts.













- 1CC21  SEPARATED BLOCK QUADRANT-1
 → 2598  quadrant upper left
 1CC22  SEPARATED BLOCK QUADRANT-2
 → 259D  quadrant upper right
 1CC23  SEPARATED BLOCK QUADRANT-12
 → 2580  upper half block
 1CC24  SEPARATED BLOCK QUADRANT-3
 → 2596  quadrant lower left
 1CC25  SEPARATED BLOCK QUADRANT-13
 → 258C  left half block
 1CC26  SEPARATED BLOCK QUADRANT-23
 → 259E  quadrant upper right and lower left

- 1CC27  SEPARATED BLOCK QUADRANT-123
 → 259B  quadrant upper left and upper right and lower left
 1CC28  SEPARATED BLOCK QUADRANT-4
 → 2597  quadrant lower right
 1CC29  SEPARATED BLOCK QUADRANT-14
 → 259A  quadrant upper left and lower right
 1CC2A  SEPARATED BLOCK QUADRANT-24
 → 2590  right half block
 1CC2B  SEPARATED BLOCK QUADRANT-124
 → 259C  quadrant upper left and upper right and lower right
 1CC2C  SEPARATED BLOCK QUADRANT-34
 → 2584  lower half block
 1CC2D  SEPARATED BLOCK QUADRANT-134
 → 2599  quadrant upper left and lower left and lower right
 1CC2E  SEPARATED BLOCK QUADRANT-234
 → 259F  quadrant upper right and lower left and lower right
 1CC2F  SEPARATED BLOCK QUADRANT-1234
 → 2588  full block



Circle segments















































- 1CC30  UPPER LEFT TWELFTH CIRCLE
 1CC31  UPPER CENTRE LEFT TWELFTH CIRCLE
 1CC32  UPPER CENTRE RIGHT TWELFTH CIRCLE
 1CC33  UPPER RIGHT TWELFTH CIRCLE
 1CC34  UPPER MIDDLE LEFT TWELFTH CIRCLE
 1CC35  UPPER LEFT QUARTER CIRCLE
 1CC36  UPPER RIGHT QUARTER CIRCLE
 1CC37  UPPER MIDDLE RIGHT TWELFTH CIRCLE
 1CC38  LOWER MIDDLE LEFT TWELFTH CIRCLE
 1CC39  LOWER LEFT QUARTER CIRCLE
 1CC3A  LOWER RIGHT QUARTER CIRCLE
 1CC3B  LOWER MIDDLE RIGHT TWELFTH CIRCLE
 1CC3C  LOWER LEFT TWELFTH CIRCLE
 1CC3D  LOWER CENTRE LEFT TWELFTH CIRCLE
 1CC3E  LOWER CENTRE RIGHT TWELFTH CIRCLE
 1CC3F  LOWER RIGHT TWELFTH CIRCLE

Fill characters

- 1CC40  SPARSE HORIZONTAL FILL
 → 25A4  square with horizontal fill
 1CC41  SPARSE VERTICAL FILL
 → 25A5  square with vertical fill
 1CC42  ORTHOGONAL CROSSHATCH FILL
 → 25A6  square with orthogonal crosshatch fill
 1CC43  DIAGONAL CROSSHATCH FILL
 → 25A9  square with diagonal crosshatch fill
 1CC44  DENSE VERTICAL FILL
 1CC45  DENSE HORIZONTAL FILL
 1CC46  SPECKLE FILL FRAME-1
 1CC47  SPECKLE FILL FRAME-2
 • The term "frame" used here refers to frames of an animation

Game sprites





- 1CC48  LEFT-FACING BASSINET
 1CC49  RIGHT-FACING BASSINET
 1CC4A  FLYING SAUCER WITH BEAMS























- 1CC4B  FLYING SAUCER WITHOUT BEAMS
 • The Sharp MZ-700 character set includes three flying saucer symbols, mapped to 1CC4A , 1CC4B , and 1F6F8 .
 → 1F6F8  flying saucer
- 1CC4C  ALIEN MONSTER OPEN JAWS
 1CC4D  ALIEN MONSTER CLOSED JAWS
 1CC4E  ALIEN SQUID OPEN TENTACLES
 1CC4F  ALIEN SQUID CLOSED TENTACLES
 1CC50  ALIEN CRAB STEPPING RIGHT
 1CC51  ALIEN CRAB STEPPING LEFT
 1CC52  ALIEN SPIDER CROUCHING
 1CC53  ALIEN SPIDER SPREAD
 1CC54  ALIEN MONSTER STEP-1
 1CC55  ALIEN MONSTER STEP-2
 1CC56  LEFT-POINTING ROCKET SHIP
 → 1F66C  leftwards rocket
- 1CC57  UP-POINTING ROCKET SHIP
 → 1F66D  upwards rocket
- 1CC58  RIGHT-POINTING ROCKET SHIP
 → 1F66E  rightwards rocket
- 1CC59  DOWN-POINTING ROCKET SHIP
 → 1F66F  downwards rocket
 → 1F680  rocket
- 1CC5A  TOP HALF LEFT-FACING ROBOT
 1CC5B  TOP HALF FORWARD-FACING ROBOT
 1CC5C  TOP HALF RIGHT-FACING ROBOT
 1CC5D  BOTTOM HALF LEFT-FACING ROBOT
 1CC5E  BOTTOM HALF FORWARD-FACING ROBOT
 1CC5F  BOTTOM HALF RIGHT-FACING ROBOT
 1CC60  LEFT-POINTING ATOMIC BOMB
 1CC61  UP-POINTING ATOMIC BOMB
 1CC62  RIGHT-POINTING ATOMIC BOMB
 1CC63  DOWN-POINTING ATOMIC BOMB
 1CC64  MUSHROOM CLOUD
 1CC65  LEFT-POINTING RIFLE
 → 1F946  rifle
- 1CC66  UP-POINTING RIFLE
 1CC67  RIGHT-POINTING RIFLE
 1CC68  DOWN-POINTING RIFLE
 1CC69  EIGHT RAYS INWARD
 1CC6A  EIGHT RAYS OUTWARD
 1CC6B  BLACK LARGE CIRCLE MINUS LEFT QUARTER SECTION
 1CC6C  BLACK LARGE CIRCLE MINUS UPPER QUARTER SECTION
 1CC6D  BLACK LARGE CIRCLE MINUS RIGHT QUARTER SECTION
 1CC6E  BLACK LARGE CIRCLE MINUS LOWER QUARTER SECTION

Emoticon



















- 1CC6F  BLACK NEUTRAL FACE
 → 1F610  neutral face

Game sprites



- 1CC70  LEFT-FACING SNAKE HEAD WITH OPEN MOUTH
 1CC71  UP-FACING SNAKE HEAD WITH OPEN MOUTH
 1CC72  RIGHT-FACING SNAKE HEAD WITH OPEN MOUTH
 1CC73  DOWN-FACING SNAKE HEAD WITH OPEN MOUTH

- 1CC74  LEFT-FACING SNAKE HEAD WITH CLOSED MOUTH
 1CC75  UP-FACING SNAKE HEAD WITH CLOSED MOUTH
 1CC76  RIGHT-FACING SNAKE HEAD WITH CLOSED MOUTH
 1CC77  DOWN-FACING SNAKE HEAD WITH CLOSED MOUTH
 1CC78  LEFT-POINTING ENERGY WAVE
 1CC79  UP-POINTING ENERGY WAVE
 1CC7A  RIGHT-POINTING ENERGY WAVE
 1CC7B  DOWN-POINTING ENERGY WAVE
 1CC7C  SQUARE SPIRAL FROM TOP LEFT
 1CC7D  SQUARE SPIRAL FROM TOP RIGHT
 1CC7E  SQUARE SPIRAL FROM BOTTOM RIGHT
 1CC7F  SQUARE SPIRAL FROM BOTTOM LEFT
 1CC80  STRIPED LEFT-POINTING TRIANGLE
 → 25C0  black left-pointing triangle
- 1CC81  STRIPED UP-POINTING TRIANGLE
 → 25B2  black up-pointing triangle
- 1CC82  STRIPED RIGHT-POINTING TRIANGLE
 → 25B6  black right-pointing triangle
- 1CC83  STRIPED DOWN-POINTING TRIANGLE
 → 25BC  black down-pointing triangle
- 1CC84  VERTICAL LADDER
 → 1FA9C  ladder
- 1CC85  HORIZONTAL LADDER











Terminal graphic characters

- 1CC86  WHITE LOWER LEFT POINTER
 → 25BB  white right-pointing pointer
 → 25FA  lower left triangle
- 1CC87  WHITE LOWER RIGHT POINTER
 → 25C5  white left-pointing pointer
 → 25FF  lower right triangle
- 1CC88  TWO RINGS ALIGNED HORIZONTALLY
 1CC89  SQUARE FOUR CORNER SALTIRES
 1CC8A  SQUARE FOUR CORNER DIAGONALS
 1CC8B  SQUARE FOUR CORNER BLACK TRIANGLES
 1CC8C  SQUARE APERTURE
 1CC8D  INVERSE BLACK DIAMOND
 → 25C6  black diamond
 → 1FBBF  negative diagonal diamond
- 1CC8E  LEFT AND UPPER ONE EIGHTH BLOCK CONTAINING BLACK SMALL SQUARE
 → 1FB7D  left and upper one eighth block
- 1CC8F  INVERSE BLACK SMALL SQUARE
 → 25AA  black small square

Lines with tick marks

- 1CC90  VERTICAL LINE WITH FOUR TICK MARKS
 1CC91  HORIZONTAL LINE WITH FOUR TICK MARKS

Game sprites

- 1CC92  LEFT-FACING FISH
 → 1F41F  fish
- 1CC93  RIGHT-FACING FISH
 1CC94  LEFT-FACING FISH WITH OPEN MOUTH
 1CC95  RIGHT-FACING FISH WITH OPEN MOUTH
 1CC96  FLAPPING BIRD
 → 1F426  bird
- 1CC97  LEFT-POINTING RACING CAR
 1CC98  UP-POINTING RACING CAR
 1CC99  RIGHT-POINTING RACING CAR

1CC9A		DOWN-POINTING RACING CAR
1CC9B		HORIZONTAL RACING CAR
1CC9C		VERTICAL RACING CAR
1CC9D		VERTICAL GO-KART
1CC9E		LEFT-POINTING TANK
1CC9F		RIGHT-POINTING TANK
1CCA0		LEFT-POINTING ROCKET BOOSTER
1CCA1		RIGHT-POINTING ROCKET BOOSTER
1CCA2		LEFT-POINTING ROLLER COASTER CAR → 1F3A2 roller coaster
1CCA3		RIGHT-POINTING ROLLER COASTER CAR
1CCA4		LEFT HALF FLYING SAUCER → 1F6F8 flying saucer
1CCA5		RIGHT HALF FLYING SAUCER
Faces		
1CCA6		UPPER LEFT QUADRANT FACE WITH OPEN EYES
1CCA7		UPPER RIGHT QUADRANT FACE WITH OPEN EYES
1CCA8		UPPER LEFT QUADRANT FACE WITH CLOSED EYES
1CCA9		UPPER RIGHT QUADRANT FACE WITH CLOSED EYES
1CCAA		LOWER LEFT QUADRANT SMILING FACE
1CCAB		LOWER RIGHT QUADRANT SMILING FACE
1CCAC		LOWER LEFT QUADRANT NEUTRAL FACE
1CCAD		LOWER RIGHT QUADRANT NEUTRAL FACE
1CCAE		LOWER LEFT QUADRANT FACE WITH OPEN MOUTH
1CCAF		LOWER RIGHT QUADRANT FACE WITH OPEN MOUTH
1CCB0		LOWER LEFT QUADRANT FROWNING FACE
1CCB1		LOWER RIGHT QUADRANT FROWNING FACE
Icons		
1CCB2		UPPER LEFT QUADRANT TELEVISION → 1F4FA television
1CCB3		UPPER RIGHT QUADRANT TELEVISION
1CCB4		LOWER LEFT QUADRANT TELEVISION
1CCB5		LOWER RIGHT QUADRANT TELEVISION
1CCB6		UPPER LEFT QUADRANT MICROCOMPUTER
1CCB7		UPPER RIGHT QUADRANT MICROCOMPUTER
1CCB8		LOWER LEFT QUADRANT MICROCOMPUTER
1CCB9		LOWER RIGHT QUADRANT MICROCOMPUTER
Chess symbols		
<i>May appear as white or black chess pieces.</i>		
1CCBA		UPPER LEFT QUADRANT CHESS KING → 2654 white chess king → 265A black chess king
1CCBB		UPPER RIGHT QUADRANT CHESS KING
1CCBC		LOWER LEFT QUADRANT CHESS KING
1CCBD		LOWER RIGHT QUADRANT CHESS KING
1CCBE		UPPER LEFT QUADRANT CHESS QUEEN → 2655 white chess queen → 265B black chess queen
1CCBF		UPPER RIGHT QUADRANT CHESS QUEEN
1CCC0		LOWER LEFT QUADRANT CHESS QUEEN
1CCC1		LOWER RIGHT QUADRANT CHESS QUEEN
1CCC2		UPPER LEFT QUADRANT CHESS ROOK → 2656 white chess rook → 265C black chess rook
1CCC3		UPPER RIGHT QUADRANT CHESS ROOK

1CCC4		LOWER LEFT QUADRANT CHESS ROOK
1CCC5		LOWER RIGHT QUADRANT CHESS ROOK
1CCC6		UPPER LEFT QUADRANT CHESS BISHOP → 2657 white chess bishop → 265D black chess bishop
1CCC7		UPPER RIGHT QUADRANT CHESS BISHOP
1CCC8		LOWER LEFT QUADRANT CHESS BISHOP
1CCC9		LOWER RIGHT QUADRANT CHESS BISHOP
1CCCA		UPPER LEFT QUADRANT CHESS KNIGHT → 2658 white chess knight → 265E black chess knight
1CCCB		UPPER RIGHT QUADRANT CHESS KNIGHT
1CCCC		LOWER LEFT QUADRANT CHESS KNIGHT
1CCCD		LOWER RIGHT QUADRANT CHESS KNIGHT
1CCCE		UPPER LEFT QUADRANT CHESS PAWN → 2659 white chess pawn → 265F black chess pawn
1CCCF		UPPER RIGHT QUADRANT CHESS PAWN
1CCD0		LOWER LEFT QUADRANT CHESS PAWN
1CCD1		LOWER RIGHT QUADRANT CHESS PAWN
Icons		
1CCD2		UPPER LEFT QUADRANT STANDING KNIGHT
1CCD3		UPPER RIGHT QUADRANT STANDING KNIGHT
1CCD4		LOWER LEFT QUADRANT STANDING KNIGHT
1CCD5		LOWER RIGHT QUADRANT STANDING KNIGHT
Outlined uppercase Latin alphabet		
1CCD6		OUTLINED LATIN CAPITAL LETTER A
1CCD7		OUTLINED LATIN CAPITAL LETTER B
1CCD8		OUTLINED LATIN CAPITAL LETTER C
1CCD9		OUTLINED LATIN CAPITAL LETTER D
1CCDA		OUTLINED LATIN CAPITAL LETTER E
1CCDB		OUTLINED LATIN CAPITAL LETTER F
1CCDC		OUTLINED LATIN CAPITAL LETTER G
1CCDD		OUTLINED LATIN CAPITAL LETTER H
1CCDE		OUTLINED LATIN CAPITAL LETTER I
1CCDF		OUTLINED LATIN CAPITAL LETTER J
1CCE0		OUTLINED LATIN CAPITAL LETTER K
1CCE1		OUTLINED LATIN CAPITAL LETTER L
1CCE2		OUTLINED LATIN CAPITAL LETTER M
1CCE3		OUTLINED LATIN CAPITAL LETTER N
1CCE4		OUTLINED LATIN CAPITAL LETTER O
1CCE5		OUTLINED LATIN CAPITAL LETTER P
1CCE6		OUTLINED LATIN CAPITAL LETTER Q
1CCE7		OUTLINED LATIN CAPITAL LETTER R
1CCE8		OUTLINED LATIN CAPITAL LETTER S
1CCE9		OUTLINED LATIN CAPITAL LETTER T
1CCEA		OUTLINED LATIN CAPITAL LETTER U
1CCEB		OUTLINED LATIN CAPITAL LETTER V
1CCEC		OUTLINED LATIN CAPITAL LETTER W
1CCEX		OUTLINED LATIN CAPITAL LETTER X
1CCEE		OUTLINED LATIN CAPITAL LETTER Y
1CCEF		OUTLINED LATIN CAPITAL LETTER Z
Outlined ASCII digits		
1CCF0		OUTLINED DIGIT ZERO
1CCF1		OUTLINED DIGIT ONE
1CCF2		OUTLINED DIGIT TWO
1CCF3		OUTLINED DIGIT THREE
1CCF4		OUTLINED DIGIT FOUR
1CCF5		OUTLINED DIGIT FIVE
1CCF6		OUTLINED DIGIT SIX





























































1CCF7 7 OUTLINED DIGIT SEVEN
 1CCF8 8 OUTLINED DIGIT EIGHT
 1CCF9 9 OUTLINED DIGIT NINE





















































Block mosaic terminal graphic characters

The term "octant" refers to block mosaics divided into eight parts.

1CD00 █ BLOCK OCTANT-3
 1CD01 █ BLOCK OCTANT-23
 1CD02 █ BLOCK OCTANT-123
 1CD03 █ BLOCK OCTANT-4
 1CD04 █ BLOCK OCTANT-14
 1CD05 █ BLOCK OCTANT-124
 1CD06 █ BLOCK OCTANT-34
 1CD07 █ BLOCK OCTANT-134
 1CD08 █ BLOCK OCTANT-234
 1CD09 █ BLOCK OCTANT-5
 1CD0A █ BLOCK OCTANT-15
 1CD0B █ BLOCK OCTANT-25
 1CD0C █ BLOCK OCTANT-125
 1CD0D █ BLOCK OCTANT-135
 1CD0E █ BLOCK OCTANT-235
 1CD0F █ BLOCK OCTANT-1235
 1CD10 █ BLOCK OCTANT-45
 1CD11 █ BLOCK OCTANT-145
 1CD12 █ BLOCK OCTANT-245
 1CD13 █ BLOCK OCTANT-1245
 1CD14 █ BLOCK OCTANT-345
 1CD15 █ BLOCK OCTANT-1345
 1CD16 █ BLOCK OCTANT-2345
 1CD17 █ BLOCK OCTANT-12345
 1CD18 █ BLOCK OCTANT-6
 1CD19 █ BLOCK OCTANT-16
 1CD1A █ BLOCK OCTANT-26
 1CD1B █ BLOCK OCTANT-126
 1CD1C █ BLOCK OCTANT-36
 1CD1D █ BLOCK OCTANT-136
 1CD1E █ BLOCK OCTANT-236
 1CD1F █ BLOCK OCTANT-1236
 1CD20 █ BLOCK OCTANT-146
 1CD21 █ BLOCK OCTANT-246
 1CD22 █ BLOCK OCTANT-1246
 1CD23 █ BLOCK OCTANT-346
 1CD24 █ BLOCK OCTANT-1346
 1CD25 █ BLOCK OCTANT-2346
 1CD26 █ BLOCK OCTANT-12346
 1CD27 █ BLOCK OCTANT-56
 1CD28 █ BLOCK OCTANT-156
 1CD29 █ BLOCK OCTANT-256
 1CD2A █ BLOCK OCTANT-1256
 1CD2B █ BLOCK OCTANT-356
 1CD2C █ BLOCK OCTANT-1356
 1CD2D █ BLOCK OCTANT-2356
 1CD2E █ BLOCK OCTANT-12356
 1CD2F █ BLOCK OCTANT-456
 1CD30 █ BLOCK OCTANT-1456
 1CD31 █ BLOCK OCTANT-2456
 1CD32 █ BLOCK OCTANT-12456
 1CD33 █ BLOCK OCTANT-3456
 1CD34 █ BLOCK OCTANT-13456
 1CD35 █ BLOCK OCTANT-23456
 1CD36 █ BLOCK OCTANT-17







1CD37 █ BLOCK OCTANT-27
 1CD38 █ BLOCK OCTANT-127
 1CD39 █ BLOCK OCTANT-37
 1CD3A █ BLOCK OCTANT-137
 1CD3B █ BLOCK OCTANT-237
 1CD3C █ BLOCK OCTANT-1237
 1CD3D █ BLOCK OCTANT-47
 1CD3E █ BLOCK OCTANT-147
 1CD3F █ BLOCK OCTANT-247
 1CD40 █ BLOCK OCTANT-1247
 1CD41 █ BLOCK OCTANT-347
 1CD42 █ BLOCK OCTANT-1347
 1CD43 █ BLOCK OCTANT-2347
 1CD44 █ BLOCK OCTANT-12347
 1CD45 █ BLOCK OCTANT-157
 1CD46 █ BLOCK OCTANT-257
 1CD47 █ BLOCK OCTANT-1257
 1CD48 █ BLOCK OCTANT-357
 1CD49 █ BLOCK OCTANT-2357
 1CD4A █ BLOCK OCTANT-12357
 1CD4B █ BLOCK OCTANT-457
 1CD4C █ BLOCK OCTANT-1457
 1CD4D █ BLOCK OCTANT-12457
 1CD4E █ BLOCK OCTANT-3457
 1CD4F █ BLOCK OCTANT-13457
 1CD50 █ BLOCK OCTANT-23457
 1CD51 █ BLOCK OCTANT-67
 1CD52 █ BLOCK OCTANT-167
 1CD53 █ BLOCK OCTANT-267
 1CD54 █ BLOCK OCTANT-1267
 1CD55 █ BLOCK OCTANT-367
 1CD56 █ BLOCK OCTANT-1367
 1CD57 █ BLOCK OCTANT-2367
 1CD58 █ BLOCK OCTANT-12367
 1CD59 █ BLOCK OCTANT-467
 1CD5A █ BLOCK OCTANT-1467
 1CD5B █ BLOCK OCTANT-2467
 1CD5C █ BLOCK OCTANT-12467
 1CD5D █ BLOCK OCTANT-3467
 1CD5E █ BLOCK OCTANT-13467
 1CD5F █ BLOCK OCTANT-23467
 1CD60 █ BLOCK OCTANT-123467
 1CD61 █ BLOCK OCTANT-567
 1CD62 █ BLOCK OCTANT-1567
 1CD63 █ BLOCK OCTANT-2567
 1CD64 █ BLOCK OCTANT-12567
 1CD65 █ BLOCK OCTANT-3567
 1CD66 █ BLOCK OCTANT-13567
 1CD67 █ BLOCK OCTANT-23567
 1CD68 █ BLOCK OCTANT-123567
 1CD69 █ BLOCK OCTANT-4567
 1CD6A █ BLOCK OCTANT-14567
 1CD6B █ BLOCK OCTANT-24567
 1CD6C █ BLOCK OCTANT-124567
 1CD6D █ BLOCK OCTANT-34567
 1CD6E █ BLOCK OCTANT-134567
 1CD6F █ BLOCK OCTANT-234567
 1CD70 █ BLOCK OCTANT-1234567
 1CD71 █ BLOCK OCTANT-18
 1CD72 █ BLOCK OCTANT-28
 1CD73 █ BLOCK OCTANT-128
 1CD74 █ BLOCK OCTANT-38

1CD75  BLOCK OCTANT-138
 1CD76  BLOCK OCTANT-238
 1CD77  BLOCK OCTANT-1238
 1CD78  BLOCK OCTANT-48
 1CD79  BLOCK OCTANT-148
 1CD7A  BLOCK OCTANT-248
 1CD7B  BLOCK OCTANT-1248
 1CD7C  BLOCK OCTANT-348
 1CD7D  BLOCK OCTANT-1348
 1CD7E  BLOCK OCTANT-2348
 1CD7F  BLOCK OCTANT-12348
 1CD80  BLOCK OCTANT-58
 1CD81  BLOCK OCTANT-158
 1CD82  BLOCK OCTANT-258
 1CD83  BLOCK OCTANT-1258
 1CD84  BLOCK OCTANT-358
 1CD85  BLOCK OCTANT-1358
 1CD86  BLOCK OCTANT-2358
 1CD87  BLOCK OCTANT-12358
 1CD88  BLOCK OCTANT-458
 1CD89  BLOCK OCTANT-1458
 1CD8A  BLOCK OCTANT-2458
 1CD8B  BLOCK OCTANT-12458
 1CD8C  BLOCK OCTANT-3458
 1CD8D  BLOCK OCTANT-13458
 1CD8E  BLOCK OCTANT-23458
 1CD8F  BLOCK OCTANT-123458
 1CD90  BLOCK OCTANT-168
 1CD91  BLOCK OCTANT-268
 1CD92  BLOCK OCTANT-1268
 1CD93  BLOCK OCTANT-368
 1CD94  BLOCK OCTANT-12368
 1CD95  BLOCK OCTANT-2368
 1CD96  BLOCK OCTANT-468
 1CD97  BLOCK OCTANT-1468
 1CD98  BLOCK OCTANT-12468
 1CD99  BLOCK OCTANT-3468
 1CD9A  BLOCK OCTANT-13468
 1CD9B  BLOCK OCTANT-23468
 1CD9C  BLOCK OCTANT-568
 1CD9D  BLOCK OCTANT-1568
 1CD9E  BLOCK OCTANT-2568
 1CD9F  BLOCK OCTANT-12568
 1CDA0  BLOCK OCTANT-3568
 1CDA1  BLOCK OCTANT-13568
 1CDA2  BLOCK OCTANT-23568
 1CDA3  BLOCK OCTANT-123568
 1CDA4  BLOCK OCTANT-4568
 1CDA5  BLOCK OCTANT-14568
 1CDA6  BLOCK OCTANT-24568
 1CDA7  BLOCK OCTANT-124568
 1CDA8  BLOCK OCTANT-34568
 1CDA9  BLOCK OCTANT-134568
 1CDAA  BLOCK OCTANT-234568
 1CDAB  BLOCK OCTANT-1234568
 1CDAC  BLOCK OCTANT-178
 1CDAD  BLOCK OCTANT-278
 1CDAE  BLOCK OCTANT-1278
 1CDAF  BLOCK OCTANT-378
 1CDB0  BLOCK OCTANT-1378
 1CDB1  BLOCK OCTANT-2378
 1CDB2 BLOCK OCTANT-12378

1CDB3  BLOCK OCTANT-478
 1CDB4  BLOCK OCTANT-1478
 1CDB5  BLOCK OCTANT-2478
 1CDB6  BLOCK OCTANT-12478
 1CDB7  BLOCK OCTANT-3478
 1CDB8  BLOCK OCTANT-13478
 1CDB9  BLOCK OCTANT-23478
 1CDBA  BLOCK OCTANT-123478
 1CDBB  BLOCK OCTANT-578
 1CDBC  BLOCK OCTANT-1578
 1CDBD  BLOCK OCTANT-2578
 1CDBE  BLOCK OCTANT-12578
 1CDBF  BLOCK OCTANT-3578
 1CDC0  BLOCK OCTANT-13578
 1CDC1  BLOCK OCTANT-23578
 1CDC2  BLOCK OCTANT-123578
 1CDC3  BLOCK OCTANT-4578
 1CDC4  BLOCK OCTANT-14578
 1CDC5  BLOCK OCTANT-24578
 1CDC6  BLOCK OCTANT-124578
 1CDC7  BLOCK OCTANT-34578
 1CDC8  BLOCK OCTANT-134578
 1CDC9  BLOCK OCTANT-234578
 1CDCA  BLOCK OCTANT-1234578
 1CDCB  BLOCK OCTANT-678
 1CDCC  BLOCK OCTANT-1678
 1CDCD  BLOCK OCTANT-2678
 1CDCE  BLOCK OCTANT-12678
 1CDCF  BLOCK OCTANT-3678
 1CDD0  BLOCK OCTANT-13678
 1CDD1  BLOCK OCTANT-23678
 1CDD2  BLOCK OCTANT-123678
 1CDD3  BLOCK OCTANT-4678
 1CDD4  BLOCK OCTANT-14678
 1CDD5  BLOCK OCTANT-24678
 1CDD6  BLOCK OCTANT-124678
 1CDD7  BLOCK OCTANT-34678
 1CDD8  BLOCK OCTANT-134678
 1CDD9  BLOCK OCTANT-234678
 1CDDA  BLOCK OCTANT-1234678
 1CDDB  BLOCK OCTANT-5678
 1CDDC  BLOCK OCTANT-15678
 1CDDD  BLOCK OCTANT-25678
 1CDDDE  BLOCK OCTANT-125678
 1CDDDE  BLOCK OCTANT-35678
 1CDDDF  BLOCK OCTANT-235678
 1CDE0  BLOCK OCTANT-1235678
 1CDE1  BLOCK OCTANT-45678
 1CDE2  BLOCK OCTANT-145678
 1CDE3  BLOCK OCTANT-245678
 1CDE4  BLOCK OCTANT-1345678
 1CDE5  BLOCK OCTANT-2345678

Game sprites

The term "frame" used here refers to frames of an animation.

1CDE6  TOP HALF STANDING PERSON
 1CDE7  BOTTOM HALF STANDING PERSON
 1CDE8  TOP HALF RIGHT-FACING RUNNER FRAME-1
 1CDE9  BOTTOM HALF RIGHT-FACING RUNNER FRAME-1
 1CDEA  TOP HALF RIGHT-FACING RUNNER FRAME-2
 1CDEB  BOTTOM HALF RIGHT-FACING RUNNER FRAME-2

1CDEC		TOP HALF LEFT-FACING RUNNER FRAME-1
1CDED		BOTTOM HALF LEFT-FACING RUNNER FRAME-1
1CDEE		TOP HALF LEFT-FACING RUNNER FRAME-2
1CDEF		BOTTOM HALF LEFT-FACING RUNNER FRAME-2
1CDF0		TOP HALF FORWARD-FACING RUNNER
1CDF1		BOTTOM HALF FORWARD-FACING RUNNER FRAME-1
1CDF2		BOTTOM HALF FORWARD-FACING RUNNER FRAME-2
1CDF3		BOTTOM HALF FORWARD-FACING RUNNER FRAME-3
1CDF4		BOTTOM HALF FORWARD-FACING RUNNER FRAME-4
1CDF5		MOON LANDER
1CDF6		TOP HALF FLAILING ROBOT FRAME-1 • bottom half is 1CDF4
1CDF7		TOP HALF FLAILING ROBOT FRAME-2
1CDF8		DOWN-POINTING AIRPLANE → 1F6E7 up-pointing airplane
1CDF9		LEFT-POINTING AIRPLANE → 2708 airplane
1CDFA		SMALL UP-POINTING AIRPLANE
1CDFB		UP-POINTING FROG • represents the frog in the Mattel Aquarius port of Frogger → 1F438 frog face
1CDFC		DOWN-POINTING FROG
1CDFD		EXPLOSION FRAME-1
1CDFE		EXPLOSION FRAME-2
1CDFF		EXPLOSION FRAME-3

Terminal graphic characters

1CE00		RIGHT HALF AND LEFT HALF WHITE CIRCLE
1CE01		LOWER HALF AND UPPER HALF WHITE CIRCLE
1CE02		EXPLOSION AT HORIZON
1CE03		UPPER HALF HEAVY WHITE SQUARE → 23B4 top square bracket
1CE04		LOWER HALF HEAVY WHITE SQUARE → 23B5 bottom square bracket
1CE05		HEAVY WHITE SQUARE CONTAINING BLACK VERY SMALL SQUARE → 2B1D • black very small square → 1F791 heavy white square → 1F794 white square containing black very small square
1CE06		WHITE VERTICAL RECTANGLE WITH HORIZONTAL BAR → 25AF white vertical rectangle
1CE07		TOP RIGHT BLACK LEFT-POINTING SMALL TRIANGLE → 25C2 black left-pointing small triangle
1CE08		FUNNEL = filter
1CE09		BOX DRAWINGS DOUBLE DIAGONAL LOWER LEFT TO MIDDLE CENTRE TO LOWER RIGHT
1CE0A		BOX DRAWINGS DOUBLE DIAGONAL UPPER LEFT TO MIDDLE CENTRE TO UPPER RIGHT
1CE0B		LEFT HALF WHITE ELLIPSE → 2B2D white horizontal ellipse
1CE0C		RIGHT HALF WHITE ELLIPSE

Dashed lines

1CE0D		LEFT HALF TRIPLE DASH HORIZONTAL → 2504 box drawings light triple dash horizontal
-------	--	---

1CE0E		RIGHT HALF TRIPLE DASH HORIZONTAL
-------	--	-----------------------------------

Lines with tick marks

1CE0F		HORIZONTAL LINE WITH TICK MARK
1CE10		LEFT HALF HORIZONTAL LINE WITH THREE TICK MARKS
1CE11		RIGHT HALF HORIZONTAL LINE WITH THREE TICK MARKS
1CE12		HORIZONTAL LINE WITH THREE TICK MARKS
1CE13		LOWER HALF VERTICAL LINE WITH THREE TICK MARKS
1CE14		UPPER HALF VERTICAL LINE WITH THREE TICK MARKS
1CE15		VERTICAL LINE WITH THREE TICK MARKS

Box drawing characters

1CE16		BOX DRAWINGS LIGHT VERTICAL AND TOP RIGHT
1CE17		BOX DRAWINGS LIGHT VERTICAL AND BOTTOM RIGHT
1CE18		BOX DRAWINGS LIGHT VERTICAL AND TOP LEFT
1CE19		BOX DRAWINGS LIGHT VERTICAL AND BOTTOM LEFT

Large type pieces

Used to generate large text headlines on HP terminals.

1CE1A		LARGE TYPE PIECE UPPER LEFT ARC
1CE1B		LARGE TYPE PIECE UPPER LEFT CORNER
1CE1C		LARGE TYPE PIECE UPPER TERMINAL
1CE1D		LARGE TYPE PIECE UPPER LEFT CROTCH
1CE1E		LARGE TYPE PIECE LEFT ARM
1CE1F		LARGE TYPE PIECE CROSSBAR
1CE20		LARGE TYPE PIECE CROSSBAR WITH LOWER STEM
1CE21		LARGE TYPE PIECE UPPER HALF VERTEX OF M
1CE22		LARGE TYPE PIECE DIAGONAL LOWER LEFT
1CE23		LARGE TYPE PIECE SHORT UPPER TERMINAL
1CE24		LARGE TYPE PIECE UPPER RIGHT ARC
1CE25		LARGE TYPE PIECE RIGHT ARM
1CE26		LARGE TYPE PIECE UPPER RIGHT CROTCH
1CE27		LARGE TYPE PIECE UPPER RIGHT CORNER
1CE28		LARGE TYPE PIECE STEM WITH RIGHT CROSSBAR
1CE29		LARGE TYPE PIECE STEM
1CE2A		LARGE TYPE PIECE DIAGONAL UPPER RIGHT AND LOWER RIGHT
1CE2B		LARGE TYPE PIECE DIAGONAL UPPER RIGHT
1CE2C		LARGE TYPE PIECE DIAGONAL LOWER RIGHT
1CE2D		LARGE TYPE PIECE SHORT LOWER TERMINAL
1CE2E		LARGE TYPE PIECE LOWER LEFT AND UPPER LEFT ARC
1CE2F		LARGE TYPE PIECE CENTRE OF K
1CE30		LARGE TYPE PIECE LOWER HALF VERTEX OF M
1CE31		LARGE TYPE PIECE UPPER HALF VERTEX OF W
1CE32		LARGE TYPE PIECE CENTRE OF X
1CE33		LARGE TYPE PIECE CENTRE OF Y
1CE34		LARGE TYPE PIECE CENTRE OF Z WITH CROSSBAR
1CE35		LARGE TYPE PIECE RAISED UPPER RIGHT ARC
1CE36		LARGE TYPE PIECE STEM WITH LEFT CROSSBAR
1CE37		LARGE TYPE PIECE LOWER RIGHT AND UPPER RIGHT ARC
1CE38		LARGE TYPE PIECE DIAGONAL UPPER LEFT AND LOWER LEFT

1CE39		LARGE TYPE PIECE STEM WITH LEFT JOINT
1CE3A		LARGE TYPE PIECE STEM WITH CROSSBAR
1CE3B		LARGE TYPE PIECE DIAGONAL UPPER LEFT
1CE3C		LARGE TYPE PIECE LOWER TERMINAL
1CE3D		LARGE TYPE PIECE LOWER LEFT CORNER
1CE3E		LARGE TYPE PIECE LOWER LEFT ARC
1CE3F		LARGE TYPE PIECE LOWER LEFT CROTCH
1CE40		LARGE TYPE PIECE CROSSBAR WITH UPPER STEM
1CE41		LARGE TYPE PIECE VERTEX OF V
1CE42		LARGE TYPE PIECE LOWER HALF VERTEX OF W
1CE43		LARGE TYPE PIECE LOWER RIGHT ARC
1CE44		LARGE TYPE PIECE LOWER RIGHT CORNER
1CE45		LARGE TYPE PIECE LOWER RIGHT ARC WITH TAIL
1CE46		LARGE TYPE PIECE LOWER RIGHT CROTCH
1CE47		LARGE TYPE PIECE STEM-45
1CE48		LARGE TYPE PIECE STEM-2345
1CE49		LARGE TYPE PIECE STEM-4
1CE4A		LARGE TYPE PIECE STEM-34
1CE4B		LARGE TYPE PIECE STEM-234
1CE4C		LARGE TYPE PIECE STEM-1234
1CE4D		LARGE TYPE PIECE STEM-3
1CE4E		LARGE TYPE PIECE STEM-23
1CE4F		LARGE TYPE PIECE STEM-2
1CE50		LARGE TYPE PIECE STEM-12

Separated mosaic terminal graphic characters











The term "sextant" refers to block mosaics divided into six parts.

1CE51		SEPARATED BLOCK SEXTANT-1
1CE52		SEPARATED BLOCK SEXTANT-2
1CE53		SEPARATED BLOCK SEXTANT-12
1CE54		SEPARATED BLOCK SEXTANT-3
1CE55		SEPARATED BLOCK SEXTANT-13
1CE56		SEPARATED BLOCK SEXTANT-23
1CE57		SEPARATED BLOCK SEXTANT-123
1CE58		SEPARATED BLOCK SEXTANT-4
1CE59		SEPARATED BLOCK SEXTANT-14
1CE5A		SEPARATED BLOCK SEXTANT-24
1CE5B		SEPARATED BLOCK SEXTANT-124
1CE5C		SEPARATED BLOCK SEXTANT-34
1CE5D		SEPARATED BLOCK SEXTANT-134
1CE5E		SEPARATED BLOCK SEXTANT-234
1CE5F		SEPARATED BLOCK SEXTANT-1234
1CE60		SEPARATED BLOCK SEXTANT-5
1CE61		SEPARATED BLOCK SEXTANT-15
1CE62		SEPARATED BLOCK SEXTANT-25
1CE63		SEPARATED BLOCK SEXTANT-125
1CE64		SEPARATED BLOCK SEXTANT-35
1CE65		SEPARATED BLOCK SEXTANT-135
1CE66		SEPARATED BLOCK SEXTANT-235
1CE67		SEPARATED BLOCK SEXTANT-1235
1CE68		SEPARATED BLOCK SEXTANT-45
1CE69		SEPARATED BLOCK SEXTANT-145
1CE6A		SEPARATED BLOCK SEXTANT-245
1CE6B		SEPARATED BLOCK SEXTANT-1245
1CE6C		SEPARATED BLOCK SEXTANT-345
1CE6D		SEPARATED BLOCK SEXTANT-1345
1CE6E		SEPARATED BLOCK SEXTANT-2345
1CE6F		SEPARATED BLOCK SEXTANT-12345
1CE70		SEPARATED BLOCK SEXTANT-6











1CE71		SEPARATED BLOCK SEXTANT-16
1CE72		SEPARATED BLOCK SEXTANT-26
1CE73		SEPARATED BLOCK SEXTANT-126
1CE74		SEPARATED BLOCK SEXTANT-36
1CE75		SEPARATED BLOCK SEXTANT-136
1CE76		SEPARATED BLOCK SEXTANT-236
1CE77		SEPARATED BLOCK SEXTANT-1236
1CE78		SEPARATED BLOCK SEXTANT-46
1CE79		SEPARATED BLOCK SEXTANT-146
1CE7A		SEPARATED BLOCK SEXTANT-246
1CE7B		SEPARATED BLOCK SEXTANT-1246
1CE7C		SEPARATED BLOCK SEXTANT-346
1CE7D		SEPARATED BLOCK SEXTANT-1346
1CE7E		SEPARATED BLOCK SEXTANT-2346
1CE7F		SEPARATED BLOCK SEXTANT-12346
1CE80		SEPARATED BLOCK SEXTANT-56
1CE81		SEPARATED BLOCK SEXTANT-156
1CE82		SEPARATED BLOCK SEXTANT-256
1CE83		SEPARATED BLOCK SEXTANT-1256
1CE84		SEPARATED BLOCK SEXTANT-356
1CE85		SEPARATED BLOCK SEXTANT-1356
1CE86		SEPARATED BLOCK SEXTANT-2356
1CE87		SEPARATED BLOCK SEXTANT-12356
1CE88		SEPARATED BLOCK SEXTANT-456
1CE89		SEPARATED BLOCK SEXTANT-1456
1CE8A		SEPARATED BLOCK SEXTANT-2456
1CE8B		SEPARATED BLOCK SEXTANT-12456
1CE8C		SEPARATED BLOCK SEXTANT-3456
1CE8D		SEPARATED BLOCK SEXTANT-13456
1CE8E		SEPARATED BLOCK SEXTANT-23456
1CE8F		SEPARATED BLOCK SEXTANT-123456

Block elements

1CE90		UPPER LEFT ONE SIXTEENTH BLOCK
1CE91		UPPER CENTRE LEFT ONE SIXTEENTH BLOCK
1CE92		UPPER CENTRE RIGHT ONE SIXTEENTH BLOCK
1CE93		UPPER RIGHT ONE SIXTEENTH BLOCK
1CE94		UPPER MIDDLE LEFT ONE SIXTEENTH BLOCK
1CE95		UPPER MIDDLE CENTRE LEFT ONE SIXTEENTH BLOCK
1CE96		UPPER MIDDLE CENTRE RIGHT ONE SIXTEENTH BLOCK
1CE97		UPPER MIDDLE RIGHT ONE SIXTEENTH BLOCK
1CE98		LOWER MIDDLE LEFT ONE SIXTEENTH BLOCK
1CE99		LOWER MIDDLE CENTRE LEFT ONE SIXTEENTH BLOCK
1CE9A		LOWER MIDDLE CENTRE RIGHT ONE SIXTEENTH BLOCK
1CE9B		LOWER MIDDLE RIGHT ONE SIXTEENTH BLOCK
1CE9C		LOWER LEFT ONE SIXTEENTH BLOCK
1CE9D		LOWER CENTRE LEFT ONE SIXTEENTH BLOCK
1CE9E		LOWER CENTRE RIGHT ONE SIXTEENTH BLOCK
1CE9F		LOWER RIGHT ONE SIXTEENTH BLOCK
1CEA0		RIGHT HALF LOWER ONE QUARTER BLOCK
1CEA1		RIGHT THREE QUARTERS LOWER ONE QUARTER BLOCK
1CEA2		LEFT THREE QUARTERS LOWER ONE QUARTER BLOCK
1CEA3		LEFT HALF LOWER ONE QUARTER BLOCK
1CEA4		LOWER HALF LEFT ONE QUARTER BLOCK
1CEA5		LOWER THREE QUARTERS LEFT ONE QUARTER BLOCK

- 1CEA6  UPPER THREE QUARTERS LEFT ONE QUARTER BLOCK
- 1CEA7  UPPER HALF LEFT ONE QUARTER BLOCK
- 1CEA8  LEFT HALF UPPER ONE QUARTER BLOCK
- 1CEA9  LEFT THREE QUARTERS UPPER ONE QUARTER BLOCK
- 1CEAA  RIGHT THREE QUARTERS UPPER ONE QUARTER BLOCK
- 1CEAB  RIGHT HALF UPPER ONE QUARTER BLOCK
- 1CEAC  UPPER HALF RIGHT ONE QUARTER BLOCK
- 1CEAD  UPPER THREE QUARTERS RIGHT ONE QUARTER BLOCK
- 1CEAE  LOWER THREE QUARTERS RIGHT ONE QUARTER BLOCK
- 1CEAF  LOWER HALF RIGHT ONE QUARTER BLOCK

Smalltalk

- 1CEB0  HORIZONTAL ZIGZAG LINE
→ 299A  vertical zigzag line
- 1CEB1  KEYHOLE
= peek
→ 1F5DD  old key
- 1CEB2  OLD PERSONAL COMPUTER WITH MONITOR IN PORTRAIT ORIENTATION
→ 1F5B3  old personal computer
- 1CEB3  BLACK RIGHT TRIANGLE CARET
• zero-advance character pointing between two glyphs
→ 2038  caret
→ 2333  slope
→ 1CC86  white lower left pointer

	1F80	1F81	1F82	1F83	1F84	1F85	1F86	1F87	1F88	1F89	1F8A	1F8B	1F8C	1F8D	1F8E	1F8F
0																
1																
2																
3																
4																
5																
6																
7																
8																
9																
A																
B																
C																
D																
E																
F																



1F8B2



1F8B3



1F8B4



1F8B5



1F8B6



1F8B7



1F8B8



1F8B9



1F8BA



1F8BB

UTC: 2022-01-25
 contact: Rebecca Bettencourt
 document: L2/21-234 L2/21-
 235
 font: Kreative Square
 Unibook
 target: Unicode 16.0

Smalltalk

1F8B2 ↷ RIGHTWARDS ARROW WITH LOWER HOOK
 → 21AA ↷ rightwards arrow with hook

Arrows for legacy computing

1F8B3 ⬇️ DOWNWARDS BLACK ARROW TO BAR
 → 2913 ⬇️ downwards arrow to bar
 → 2B07 ⬇️ downwards black arrow
 → 2B73 ⬇️ downwards triangle-headed arrow to bar

1F8B4 ⬅️ NEGATIVE SQUARED LEFTWARDS ARROW
 → 2190 ⬅️ leftwards arrow

1F8B5 ⬆️ NEGATIVE SQUARED UPWARDS ARROW
 → 2191 ⬆️ upwards arrow

1F8B6 ➡️ NEGATIVE SQUARED RIGHTWARDS ARROW
 → 2192 ➡️ rightwards arrow

1F8B7 ⬇️ NEGATIVE SQUARED DOWNWARDS ARROW
 → 2193 ⬇️ downwards arrow

Arrows with bar





































These arrows complement the set in the range 21A4-21A7.

1F8B8 ↖️ NORTH WEST ARROW FROM BAR

1F8B9 ↗️ NORTH EAST ARROW FROM BAR

1F8BA ↘️ SOUTH EAST ARROW FROM BAR

1F8BB ↙️ SOUTH WEST ARROW FROM BAR

	1FB0	1FB1	1FB2	1FB3	1FB4	1FB5	1FB6	1FB7	1FB8	1FB9	1FBA	1FBB	1FBC	1FBD	1FBE	1FBF
0	[Hatched]															
1	[Hatched]															
2	[Hatched]															
3	[Hatched]															
4	[Hatched]															
5	[Hatched]															
6	[Hatched]															
7	[Hatched]															
8	[Hatched]															
9	[Hatched]															
A	[Hatched]															
B	[Hatched]															
C	[Hatched]															
D	[Hatched]															
E	[Hatched]															
F	[Hatched]															

UTC: 2022-01-25
 WG2:
 contact: Rebecca Bettencourt
 document: L2/21-235
 font: Kreative Square
 Unibook
 target: Unicode 16.0

Terminal graphic characters

- 1FBCE ☒ WHITE CROSS MARK
 → 274C ✕ cross mark
- 1FBCE ☐ RAISED SMALL LEFT SQUARE BRACKET
- 1FBCE ▲ BLACK SMALL UP-POINTING CHEVRON
 → 1F835 ↗ upwards finger-post arrow
 → 1FBCA ⬆ white up-pointing chevron

Block elements

- 1FBCE █ LEFT TWO THIRDS BLOCK
- 1FBCE █ LEFT ONE THIRD BLOCK

Character cell diagonals

- 1FBDE ↘ BOX DRAWINGS LIGHT DIAGONAL MIDDLE
 RIGHT TO LOWER LEFT
- 1FBDE ↗ BOX DRAWINGS LIGHT DIAGONAL UPPER
 RIGHT TO MIDDLE LEFT
- 1FBDE ↖ BOX DRAWINGS LIGHT DIAGONAL UPPER LEFT
 TO MIDDLE RIGHT
- 1FBDE ↘ BOX DRAWINGS LIGHT DIAGONAL MIDDLE
 LEFT TO LOWER RIGHT
- 1FBDE ↖ BOX DRAWINGS LIGHT DIAGONAL UPPER LEFT
 TO LOWER CENTRE
- 1FBDE ↘ BOX DRAWINGS LIGHT DIAGONAL UPPER
 CENTRE TO LOWER RIGHT
- 1FBDE ↗ BOX DRAWINGS LIGHT DIAGONAL UPPER
 RIGHT TO LOWER CENTRE
- 1FBDE ↗ BOX DRAWINGS LIGHT DIAGONAL UPPER
 CENTRE TO LOWER LEFT
- 1FBDE ✓ BOX DRAWINGS LIGHT DIAGONAL UPPER LEFT
 TO MIDDLE CENTRE TO UPPER RIGHT
- 1FBDE < BOX DRAWINGS LIGHT DIAGONAL UPPER
 RIGHT TO MIDDLE CENTRE TO LOWER RIGHT
- 1FBDE ^ BOX DRAWINGS LIGHT DIAGONAL LOWER
 LEFT TO MIDDLE CENTRE TO LOWER RIGHT
- 1FBDE > BOX DRAWINGS LIGHT DIAGONAL UPPER LEFT
 TO MIDDLE CENTRE TO LOWER LEFT
- 1FBDE ✓ BOX DRAWINGS LIGHT DIAGONAL UPPER LEFT
 TO LOWER CENTRE TO UPPER RIGHT
- 1FBDE < BOX DRAWINGS LIGHT DIAGONAL UPPER
 RIGHT TO MIDDLE LEFT TO LOWER RIGHT
- 1FBDE ^ BOX DRAWINGS LIGHT DIAGONAL LOWER
 LEFT TO UPPER CENTRE TO LOWER RIGHT
- 1FBDE > BOX DRAWINGS LIGHT DIAGONAL UPPER LEFT
 TO MIDDLE RIGHT TO LOWER LEFT

Geometric shapes

- 1FBE0 ☺ OP JUSTIFIED LOWER HALF WHITE CIRCLE
 → 25E1 ☺ lower half circle
- 1FBE1 ☺ RIGHT JUSTIFIED LEFT HALF WHITE CIRCLE
 → 1F907 ☺ left half circle
- 1FBE2 ☺ BOTTOM JUSTIFIED UPPER HALF WHITE CIRCLE
 → 2312 ☺ arc
 → 25E0 ☺ upper half circle
- 1FBE3 ☺ LEFT JUSTIFIED RIGHT HALF WHITE CIRCLE
- 1FBE4 █ UPPER CENTRE ONE QUARTER BLOCK
- 1FBE5 █ LOWER CENTRE ONE QUARTER BLOCK
- 1FBE6 █ MIDDLE LEFT ONE QUARTER BLOCK
- 1FBE7 █ MIDDLE RIGHT ONE QUARTER BLOCK
- 1FBE8 ☾ TOP JUSTIFIED LOWER HALF BLACK CIRCLE
 → 2BCB ☾ bottom half black circle
- 1FBE9 ☾ RIGHT JUSTIFIED LEFT HALF BLACK CIRCLE
 → 25D6 ☾ left half black circle
- 1FBEA ☾ BOTTOM JUSTIFIED UPPER HALF BLACK CIRCLE
 → 2BCA ☾ top half black circle

- 1FBE8 ☾ LEFT JUSTIFIED RIGHT HALF BLACK CIRCLE
 → 25D7 ☾ right half black circle
- 1FBE9 ☾ TOP RIGHT JUSTIFIED LOWER LEFT QUARTER
 BLACK CIRCLE
- 1FBEA ☾ BOTTOM LEFT JUSTIFIED UPPER RIGHT
 QUARTER BLACK CIRCLE
- 1FBEA ☾ BOTTOM RIGHT JUSTIFIED UPPER LEFT
 QUARTER BLACK CIRCLE
- 1FBEA ☾ TOP LEFT JUSTIFIED LOWER RIGHT QUARTER
 BLACK CIRCLE